

Volume VII: Compressed Air and Inert Gas Piping Systems

Industrial Technical
Manual Series

FOURTH EDITION



IPEX

Duratec[®]
AIRLINE SYSTEM



IPEX Duratec® Compressed Air and Inert Gas Piping Systems

Industrial Technical Manual Series

Vol. VII, 4th Edition

© 2014 by IPEX. All rights reserved.

No part of this book may be used or reproduced in any manner whatsoever without prior written permission. For information contact: IPEX, Marketing, 2441 Royal Windsor Drive, Mississauga, Ontario, Canada, L5J 4C7.

LITERATURE & WEBSITE DISCLAIMER

The information contained here within is based on current information and product design at the time of publication and is subject to change without notification. IPEX does not guarantee or warranty the accuracy, suitability for particular applications, or results to be obtained therefrom.

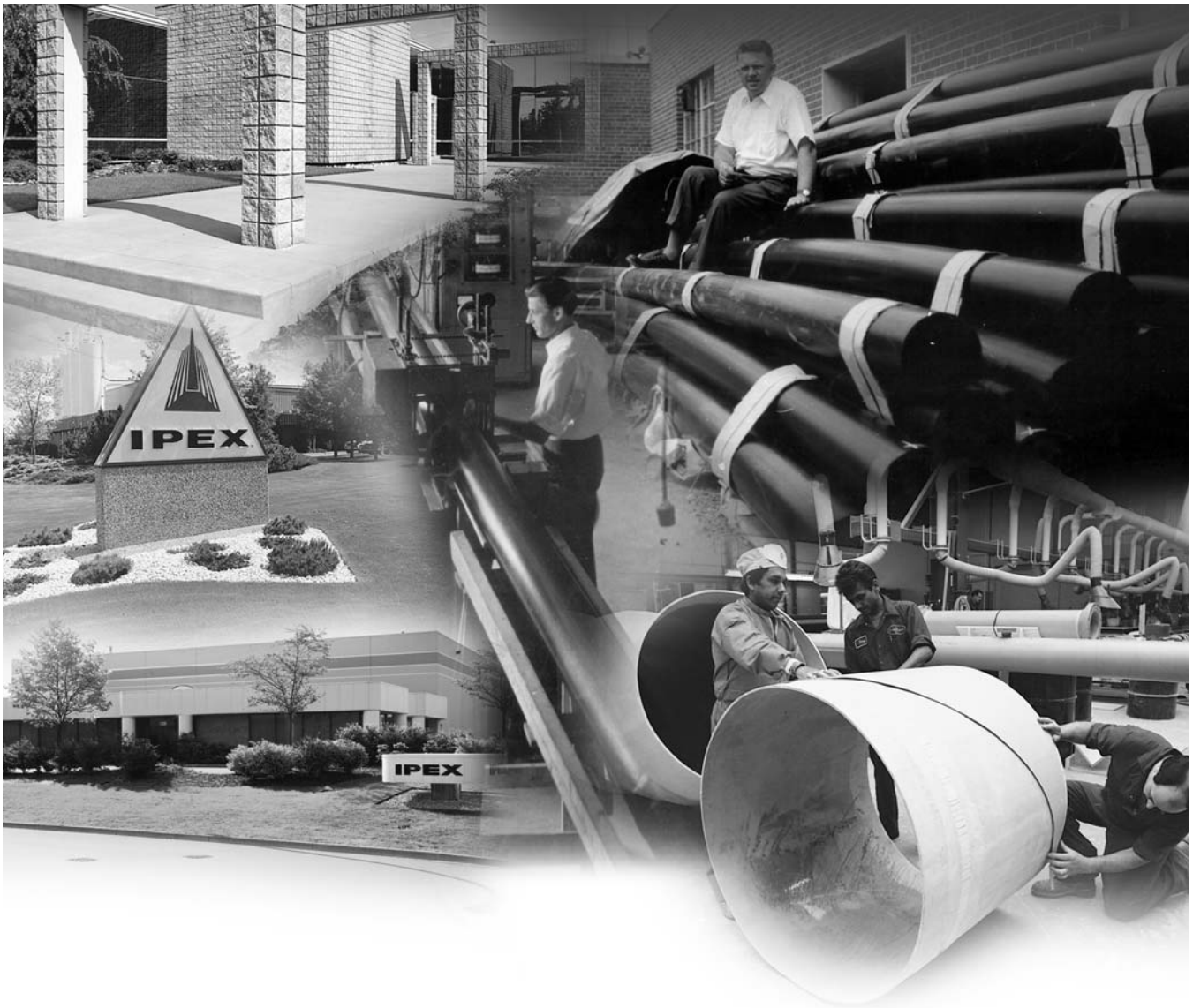

ABOUT IPEX

At IPEX, we have been manufacturing non-metallic pipe and fittings since 1951. We formulate our own compounds and maintain strict quality control during production. Our products are made available for customers thanks to a network of regional stocking locations throughout North America. We offer a wide variety of systems including complete lines of piping, fittings, valves and custom-fabricated items.

More importantly, we are committed to meeting our customers' needs. As a leader in the plastic piping industry, IPEX continually develops new products, modernizes manufacturing facilities and acquires innovative process technology. In addition, our staff take pride in their work, making available to customers their extensive thermoplastic knowledge and field experience. IPEX personnel are committed to improving the safety, reliability and performance of thermoplastic materials. We are involved in several standards committees and are members of and/or comply with the organizations listed on this page.

For specific details about any IPEX product, contact our customer service department.



SAFETY ALERTS

Engineered thermoplastics are safe inert materials that do not pose any significant safety or environmental hazards during handling or installation. However, improper installation or use can result in personal injury and/or property damage. It is important to be aware of and recognize safety alert messages as they appear in this manual.

The types of safety alert messages are described below.



This safety alert symbol indicates important safety messages in this manual. When you see this symbol be alert to the possibility of personal injury and carefully read and fully understand the message that follows.

Note: The use of the word “NOTE” signifies special instructions which are important but are not related to hazards.

WARNING

“WARNING” identifies hazards or unsafe practices that can result in severe personal injury or death if instructions, including recommended precautions, are not followed.

CAUTION

“CAUTION” identifies hazards or unsafe practices that can result in minor personal injury or product or property damage if instructions, including recommended precautions, are not followed.

WARNING

- **NEVER** use compressed air or gas in PVC/CPVC/PP/PVDF pipe and fittings.
- **NEVER** test PVC/CPVC/PP/PVDF pipe and fittings with compressed air or gas, or air-over-water boosters.
- **ONLY** use PVC/CPVC/PP/PVDF pipe for water and approved chemicals.



Use of compressed air or gas in PVC/CPVC/PP/PVDF pipe and fittings can result in explosive failures and cause severe injury or death.

WARNING

Duratec is only suitable for compressed air and inert gases.

NOTES

CONTENTS

Compressed Air and Inert Gas Piping Systems

About IPEX

Safety Alertsi

Section One: General Information

Overview1

Standards1

Features & Benefits2

Applications3

Section Two: Material Properties

Material Description5

Material Description - Pipe5

Material Description - Fittings5

Material Characteristics6

Section Three: Design Data

Design Considerations7

System Sizes7

Pressure Ratings7

Pressure Loss Through Fittings7

Compressed Air and Inert Gas Constants7

Thermal Expansion8

Contaminants8

General Considerations for Piping System Design8

Sizing Duratec Air-Line Systems9

Determining Pressure Loss in Duratec Air-Line Systems

Using Pressure Drop Charts12

Section Four: Handling and Installation

Storage15

Fitting Installation15

Making a Threaded Connection16

Pipe Supports16

Bending Duratec Pipe17

Quick Release Coupling Connections17

Electrical Grounding18

Testing Duratec Systems18

Exposure to Sunlight18

Burial18

Section Five: Dimensional Data
Dimensions19

Section Six: Specifications
Short Form Specification23
Duratec Pipe Materials23
Duratec Fitting Materials23
Dimensions23
Marking23
Sample Specification23

Section Seven: Appendices
Appendix A - Glossary25
Compressed Air System Glossary25
Conversion Glossary26
Appendix B – Pressure Loss Charts (ACFM)27
Appendix C – Pressure Loss Charts (SCFM)34

SECTION ONE: GENERAL INFORMATION

Overview

Duratec® Air-Line is a new innovative compressed air and inert gas piping product that uniquely combines all of the benefits of plastic and metal in one pipe. Duratec is constructed of an inner and outer layer of HDPE sandwiched over an aluminum core. This unique construction makes Duratec Air-Line a lightweight, clean, non-corroding compressed air and inert gas distribution system.

Modern process equipment, pneumatic controls and instrumentation demand a supply of clean, uncontaminated air that has necessitated the development of new designs of compressors, ancillary equipment and new piping systems like Duratec.

Duratec's polyethylene inner liner provides for a lifetime of smooth flow. Unlike metal products Duratec will not scale, pit or corrode and provides constant flow with no increase in pressure drop over time.

Duratec's aluminum core provides strength, rigidity, flexibility and toughness when combined with an engineered mix of polyethylene.

The outer polyethylene layer provides not only a permanent blue color coding to identify the system, it provides chemical, corrosion, UV and moisture protection to ensure a long system life.

This unique construction allows Duratec to be manufactured in four sizes from 3/8" through 1" and handle 200 psi at 73°F and 160 psi at 140°F.



Standard

Duratec pipe is manufactured to ASTM F1282 (ANSI certified) and CSA B137.9

Duratec fittings are manufactured to ASTM F1974 and carry a national pressure vessel CRN# OAO2020.2C. *(Some fittings do not have CRN registration. Contact IPEX for details.)*

Duratec has been third party tested by NSF to CAL OSHA sustained pressure and impact requirements for compressed air systems.

Duratec pipe is third party listed by Warnock Hersey to the requirements of ULC S102.2 for a Flame Spread of 5 and a Smoke Developed of 5.

Duratec meets the requirements of ASME B31.3 and B31.9 Codes.

Duratec is also approved by CAL OSHA for use in compressed air and inert gas applications.



FEATURES & BENEFITS

Safety

The unique construction of Duratec affords resistance to accidental damage from impact. Duratec has been tested to impacts with blunt and sharp strikers at temperatures from 32°F (0°C) to 140°F (60°C) validating its ductility and impact resistance required for compressed air service.

Low Installation Costs

Duratec Air-Line pipe reduces costs on a typical installation not only for materials but also for labor and transportation costs when compared to traditional materials. The reason? Its lightweight construction and simple assembly procedures. Like all thermoplastics, Duratec is easily handled, stored, cut, joined and installed. As a result, project costs for installed Duratec systems are significantly lower. Requirements for heavy installation equipment are also eliminated.

Clean

All Duratec pipe is packaged in cardboard boxes preventing contamination before use. The smooth HDPE inner layer cannot rust, corrode or form loose scale. Clean air remains clean throughout the life of the system.

Corrosion Resistant

Corrosion is a continuous problem with metal systems in compressed air applications. The corroded metal from the pipe wall can be carried by the air and clog tools, instruments and machinery. This problem is eliminated with the corrosion resistant Duratec Air-Line system.

Smooth Interior

Less friction means lower pressure drops and higher flow rates. This may allow for smaller pipe sizes to be used.

Extended Life

Once properly selected for the application and correctly installed, Duratec Air-Line systems will provide years of maintenance free service. Our Air-Line system is designed not to rust, scale, pit or corrode.

Ease of Handling

Duratec is 75% lighter than the weight of the equivalent diameter of copper and SCH 40 carbon steel.

Quick Removable Connections

Threading is not required. All joints are double o-ring seals and can be quickly assembled or disassembled. Easy on-site modifications and repairs can be made.

Quick Installation

No special training or equipment is required to complete a Duratec system.

Fewer Fittings

Duratec pipe comes in convenient 100 ft. and 300 ft. coils eliminating several joints and the need for threading, fusing, or solvent cementing.

Flexible Yet Rigid

Due to its composite structure, Duratec pipe can be easily bent by hand and will maintain its desired shape.



APPLICATIONS

- Plant air
- Manufacturing hand tool operation
- Manual and automated welding operations
- Food and beverage – CO₂ delivery
- Semi-conductor tool hook up
- Valve actuation – control systems
- Microbulk gas delivery systems of inert gases
- Robotic installations

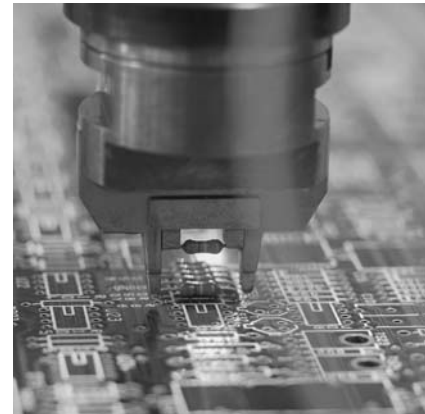

NOTES

SECTION TWO: MATERIAL PROPERTIES

MATERIAL DESCRIPTION

Material Description – Pipe

Duratec pipe meets the stringent requirements of ANSI/ASTM F1282 as well as CSA B137.9. This unique pipe design provides high strength and pressure ratings, while offering the benefits of a pipe that bends easily and stays bent. Large inside diameters provide excellent flow rates.

Duratec pipe is constructed of an inner and outer layer of high density polyethylene and a center core of aluminum. The high density polyethylene contributes approximately 30% to the overall strength of the Duratec pipe. The remaining 70% comes from the aluminum. Together the two materials, HDPE and aluminum, provide the end user with all of the advantages of plastic and metal, in a revolutionary composite air-line pipe.

Some of the advantages include:

HDPE	Aluminum
1. Corrosion proof	1. Rigidity
2. Flexibility	2. No memory - “stays where it lays”
3. Ease of installation	3. High mechanical strength
4. Improved air/gas quality	4. High temperature capability
5. No scaling	5. High pressure capability
6. All weather installation	6. Permanent permeation barrier
7. Condensation resistance	7. Low expansion and contraction

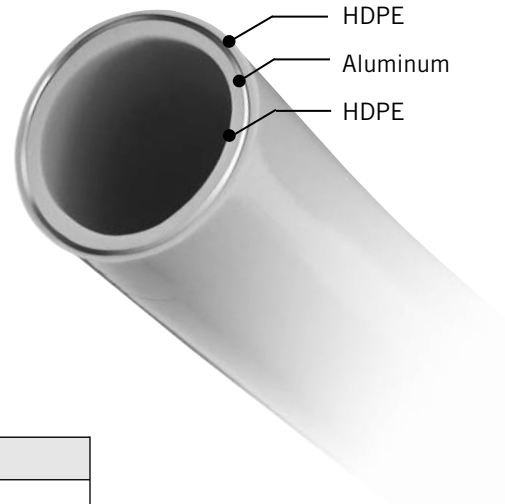

MATERIAL PROPERTIES

The HDPE used in the manufacture of Duratec is a member of the polyolefin group. It is a tough and flexible material even at cold temperatures. Duratec HDPE is formulated with a UV-inhibited blue pigment designed to screen out ultra-violet radiation.

The aluminum material used in Duratec has a minimum elongation of 20% and ultimate tensile strength of 14,600 psi (100 mPa) when tested in accordance with ASTM E8.

Material Description – Fittings

The Duratec system uses a unique and cost effective D1 nickel plated brass insert fitting for easy connections. All Duratec fittings are protected with a corrosion resistant, industrial strength nickel plating.

These fittings are easily attached to Duratec pipe using a split ring and locking nut mechanism. A full range of male, female thread and tubing adapters are available as well as tees, couplings and valves.

Duratec fittings are manufactured in accordance with ASTM F1974 which details specific requirements for brass alloys, o-ring materials, fitting dimensions and performance requirements. Duratec fittings also carry a national pressure vessel CRN# OA02020.2C. (*Some fittings do not have CRN registration. Contact IPEX for details.*)

Duratec also has male adapters manufactured in 316 stainless steel for easy conversion to threaded stainless steel fittings for systems where nickel plated brass is not acceptable.

Table 1 – Material Properties

Properties	Pipe Properties		Fitting Properties		ASTM	Units
	HDPE	Aluminum	Nickel Plated Brass	316 S.S.		
Hardness, shore D	59	–	–	–	D2240	–
Tensile Strength	4,800 (33)	–	40,000 (275)	75,000 (515)	D882	psi (MPa)
Yield Strength	2,800 (19)	14,600 (100)	15,000 (105)	30,000 (205)	D882	psi (MPa)
Elongation	550	20	10	40	D882	%

MATERIAL CHARACTERISTICS

Chemical Resistance

IPEX offers a complete Duratec Air-Line system of pipe, fittings and valves with outstanding resistance to a wide range of compressor oils and lubricants. Due to the numerous compressor oils used in modern compressors please consult our technical bulletin on Duratec Chemical Compatibility. As compressor oil technology evolves IPEX will update this bulletin accordingly. Please consult your local IPEX representative for most recent information.

Impact Strength

Extensive impact testing has shown Duratec Air-Line to be a safe, reliable product for compressed air and inert gas applications.

Duratec pipe was tested to OSHA standards and exceeds all of the requirements as required by the California Code of Regulations for Unfired Pressure Vessel Safety Orders (Cal OSHA).

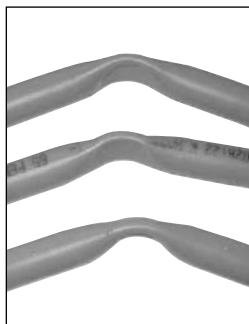

Table 2 – Impact Tests

Nominal Sizes	Tup A No Pressure @ 32°F	Tup B 200 psi @ 32°F	Chisel Tup 200 psi @ 32°F
Impact Energy Ft.-lb.			
3/8"	22	44	44
1/2"	33	66	66
3/4"	43	86	86
1"	54	108	108
Pass	No Cracking	No Fragments	No Fragments

Duratec Air-Line exceeded all of the above requirements.

Mode of Failure

Duratec pipe is a ductile system with a mode of failure that resembles soft copper. Failure is by ductile distortion and tearing, and is localized in nature which minimizes the loss of the pipe contents. In contrast, the failure of a rigid material is accompanied by rapid crack propagation and hazardous material fragmentation.



Toxicity

Duratec Air-Line is an excellent choice for the delivery of gaseous carbon dioxide in food and beverage applications.

The HDPE used in the Duratec pipe complies with the specifications contained in the U.S. Food and Drug Administration (FDA) regulation 21 CFR 177.1520 for olefin polymers, para. (c) 3.2a, and may be used as an article or component of an article intended for use in contact with food.

The stainless steel (SS) used in the SS D1 male adapter complies with the requirements of the Federal Food Drug & Cosmetic (FD&C) Act. Specifically, Duratec SS D1 male adapters are manufactured from AISI 316 Series alloy with a minimum chromium content of 16%.

The Duratec nickel plated brass D1 fittings are intended for industrial applications as copper and brass alloys are somewhat limited for use in food environments.

Pipe Wall Permeation

The unique composite construction of the Duratec Air-Line pipe eliminates permeation of air through the pipe wall ensuring the delivery of pure gases. Duratec was tested for oxygen permeability through the pipe wall to a European standard and exceeds all of the requirements of DIN 4726.

SECTION THREE: DESIGN DATA

DESIGN CONSIDERATIONS

System Sizes

The Duratec Air-Line system is manufactured in four sizes from 3/8" through 1" and has comparable diameters to copper pipe.

Table 3 – Internal Diameters

Nominal	I.D. (in)	I.D. (mm)
3/8"	0.345	9
1/2"	0.500	12
3/4"	0.805	20
1"	1.030	25

Pressure Ratings

Duratec pipes are rated for continuous operating pressures of 200 psi at 73°F and 160 psi at 140°F. Below is a derating curve of installation environments including elevated temperatures.

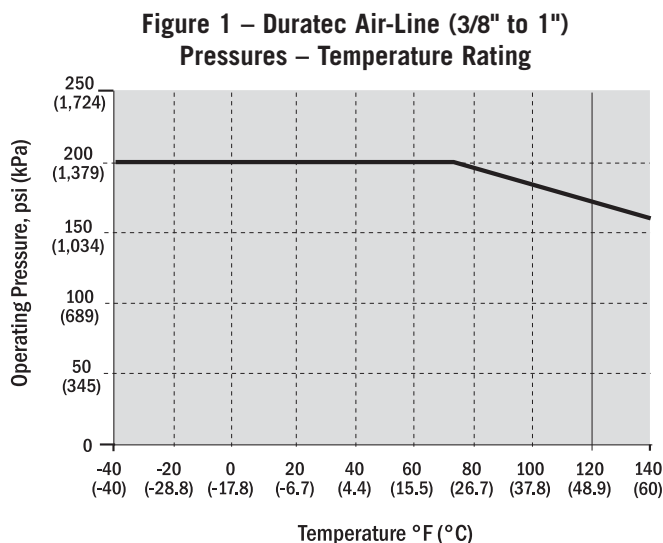

Note: This chart is applicable for all diameters.

! WARNING

Duratec pipes are not intended for use in conditions below -40°F (-40°C).

Pressure Loss Through Fittings

The long coil length and flexibility of Duratec Air-Line often eliminates the use of fittings in a compressed air system. If the system does require fittings they will represent an additional pressure drop in equivalent feet of pipe.

Note: Please consult Appendix B for Pressure Loss tables for fittings at various gauge pressures and temperatures.

The following general design parameters can also be used as a guide when calculating piping systems' total pressure drop:

1. Equipment drop leg: 2 psi (13.8 kPa) loss (1 psi [6.9 kPa] is possible)
2. Hose allowance: 2 to 5 psi (13.8 to 34.5 kPa) loss
3. Quick disconnect coupling: 4 psi (27.6 kPa) loss
4. Lubricator: 1 to 4 psi (6.9 to 27.6 kPa) loss
5. Point-of-use filter: 1/2 to 2 psi (3.4 to 13.8 kPa) loss

Compressed Air and Inert Gas Constants

Duratec Air-Line is suitable for compressed air and several inert gases. During the design process these gases should be considered individually as each has its own unique properties.

Table 4 – Individual Gas Constants – R

Gas	U.S. Units (ft-lbf/slug-°R)	SI Units (J/kg-k)
Argon, Ar	1,244	208
Carbon Dioxide, CO ₂	1,130	189
Helium, He	12,420	2,077
Nitrogen, N ₂	1,775	297
Oxygen, O ₂	1,544	260
Air	1,716	287

Duratec and Industrial Grade Gaseous Oxygen (IGGO)

IPEX Duratec Airline PE-AL-PE is suitable for the conveyance of Industrial Grade Gaseous Oxygen (IGGO) within the following parameters:

1. For continuous use of Duratec with IGGO at 73°F (23°C), IPEX recommends a maximum pressure of 100 psi with a system design life of 10 years.
2. For continuous use of Duratec with IGGO at 140°F (60°C), IPEX recommends a maximum pressure of 80 psi with a system design life of 10 years.

! WARNING

Use of Oxygen in Duratec pipe and fittings above these parameters can result in explosive failures and cause severe injury or death.

Note: Check with the local authority having jurisdiction to confirm the use of Duratec with oxygen systems. Due to oxidation, the operating life of Duratec pipe conveying IGGO is expected to be one fifth (10 years) of Duratec pipe used in compressed air applications.

Thermal Expansion

Duratec composite pipes have a low coefficient of thermal expansion, similar to copper pipe. It is about 1/10th of the expansion rate of most plastic pipes. This eliminates the need to install “offsets” and the concern of pipe abrasion from movement due to temperature changes. The coefficient of thermal expansion is 1.3×10^{-5} in./in./°F. As an example, 100 feet of Duratec pipe with a 10°F rise in temperature will expand 0.156 inches.

Contaminants

There are four general classes of contamination:

1. Liquids (oil and water)
2. Vapor (oil, water, and hydrocarbons)
3. Gas
4. Particulates

An understanding of the various pollutants in the air is helpful when an engineer has to decide what equipment is required to effectively reduce or remove them. The required level of protection from the various contaminants depends upon the purpose for the air. Prior to the selection of equipment the performance criteria for each system, along with the identity and quantity of pollutants, must be determined.

General Considerations for Piping System Design

A compressed air system must be controlled, regulated, and sized to ensure that an adequate volume of air, at a specific pressure and purity, will satisfy user requirements during the period of heaviest use.

Overview of Design

1. Locate each process, work station, or piece of equipment that uses compressed air. They should be located on a plan, and a complete list should be made to simplify record keeping. This initial process will act as a beginning for your piping layout.
2. Determine the volume of air and pressure range used at each location. Information regarding pressure and flow rates for equipment such as tools can be obtained from the manufacturer. If the pressure and flow rates are not known, assign some preliminary rates until the specific values can be obtained.
3. Determine the system conditioning requirements for each piece of equipment. This includes the allowable moisture content, particulate size, and oil content. The system may require conditioning equipment including dryers, filters, lubricators and pressure regulators.
4. Establish how much time the individual tool or process will be in actual use for a one-minute period of time.

This is referred to as the “duty cycle.” In most industrial applications, tools or operations of a similar nature are usually grouped together.

5. Establish the maximum number of locations that may be used simultaneously on each branch, on each main, and for the project as a whole. This is known as the “use factor.”
6. Establish the extent of allowable leakage. Leakage is a result of the number and type of connections, the use of disconnects, the age of the system and the quality of the initial assembly process. Many small tools and operations will result in more leakage than fewer larger applications. A well maintained compressed air system will have an allowable leakage rate of 2% to 5%.

Note: This allowable leakage rate applies only to compressed air made on site. All other inert gas systems must be designed with the strictest health and safety considerations in mind including preventing leakage of any pipe contents.
7. Establish any allowance for future expansion. Thought should be given to oversizing some components (i.e., main supply lines) to avoid the cost of replacement at a later date.
8. Make a preliminary piping layout and assign a preliminary pressure drop for the system.
9. Select the air compressor type, conditioning equipment, equipment location, and air inlet, making sure that scfm (L/min) is used consistently for both the system and compressor capacity rating.

To start, the following information must be available:

- Total connected flow rate cfm (L/min) of all air-using devices, including flow to the air dryer system if applicable.
- Maximum pressure (psi) all air-using devices require.
- Duty cycle and use factors for these devices giving maximum expected use of air.
- Leakage and future expansion allowance, cfm (L/min).
- Allowable pressure drops for the entire system, including piping and conditioning equipment.
- Altitude, temperature, and contaminant removal corrections.
- Location where adequate space is available for air compressor and all ancillary equipment.
- Produce a final piping layout and size the piping network.

SIZING DURATEC AIRLINE SYSTEMS

As air flows through the Duratec piping system, it will experience friction resistance between the air and the pipe wall resulting in a pressure loss. This pressure loss is a result of the air:

- Density (ρ)
- Dynamic viscosity (μ)
- Velocity (V)
- Temperature (T)
- Smoothness of the pipe wall (C)
- Type of flow (Turbulent)

The pressure drops in the Duratec Air-Line pipe can be estimated in two ways using a modified Hazen-Williams relationship for air flows.

- Calculations using Hazen-Williams relationship for air flows equations.
- Using pressure drop graphs for Duratec pipe (provided in Appendices B & C).

Conversion of SCFM to ACFM

$$ACFM = SCFM \cdot \frac{P_s}{P_a - (\text{ppm} \times RH)} \cdot \frac{T_a}{T_s}$$

where:

- P_s = Standard pressure, psia (Pa)
- P_a = Atmospheric pressure, psia (Pa)
- ppm = Partial pressure of moisture at atmospheric temperature
- RH = Relative humidity
- T_a = Atmospheric temperature, °F + 459.7 °R (°C + 273.15 K)
- T_s = Standard temperature, °F + 459.7 °R (°C + 273.15 K)

The standard reference conditions used in this manual are: a temperature of 60 °F (15.5 °C), pressure of 14.7 psi (101325 Pa), and 0% RH. The charts in Appendix C have been developed using these values.

Pressure Loss Calculation Method:

Note: Where applicable, SI units and values are provided in parentheses.

Based on the Hazen-Williams relationship, the pressure loss can be expressed as:

where:

$$\Delta p = A \cdot \left(\frac{V}{C}\right)^n \cdot \left(\frac{1}{D}\right)^m \cdot \rho \cdot g \cdot L \quad \text{Eqn. (1)}$$

$$\Delta p = A \cdot \left(\frac{4}{\pi \cdot C}\right) Q^n \cdot D^{-m-2n} \cdot \rho \cdot g \cdot L$$

= Pressure drop, psi (Pa)

- A = Empirical constant (dimensional)
- V = Gas bulk velocity at inlet, ft/s (m/s)
- C = Pipe roughness coefficient, 150 for Duratec
- n = Empirical constant, 1.848
- D = Inner pipe diameter, in (m)
- m = Empirical constant, 1.167
- ρ = System absolute air density, slugs/ft³ (kg/m³)
- g = Gravitational constant, 32.17 ft/s² (9.81 m/s²)
- L = Length of the pipe, ft (m)
- Q = Volumetric air flow rate at inlet (actual conditions), ft³/s (m³/s)

Subject to NFPA Standard 54-1988, the coefficient A is corrected for the changes in viscosity according to where:

$$A = A_0 \cdot \left(\frac{\mu}{\mu_0} \cdot \frac{\rho_0}{\rho}\right)^{2-n} \quad \text{Eqn. (2)}$$

$$A_0 = A_0 \cdot \left(\frac{T}{T_0}\right)^{s(2-n)} \cdot \left(\frac{\rho_0}{\rho}\right)^{2-n}$$

Empirical constant (dimensional), 5630 (10.28)

- μ = Dynamic viscosity, centipoise
- μ_0 = Reference dynamic viscosity, 0.0180 centipoise
- ρ_0 = Reference absolute air density, 2.373 x 10⁻³ slugs/ft³ (1.224 kg/m³)
- T = System absolute air temperature, °F + 459.7 °R (°C + 273.15 K)
- T_0 = Reference absolute air temperature for air viscosity, 60 °F (15.5 °C)
- s = Empirical constant, 0.67

Since air is compressible, the change in density due to the pressure loss must be accounted for. The volumetric flow rate changes as a result of the density change, since, by continuity, the mass flow rate, M , remains constant. Thus, it is preferable to express Eqn. (1) in terms of M such that:

$$\Delta p = \frac{\Psi}{\rho}, \text{ where:} \quad \text{Eqn. (3)}$$

$$\Psi = A_0 \cdot \left(\frac{4}{\pi \cdot C} \right)^n \cdot \left(\frac{T}{T_0} \right)^{s(2-n)} \cdot M^n \cdot \rho_0^{2-n} \cdot D^{-m-2n} \cdot g \cdot L$$

The flow is assumed to be isothermal, which is reasonable for a long, exposed (i.e. not insulated) pipe. Therefore, Ψ is constant and the only variable is the density, which depends only on the pressure. The density of air is calculated from the ideal gas law:

$$\rho = \frac{P}{R \cdot T} \quad \text{Eqn. (4)}$$

where:

P = System absolute pressure inside the pipe,
psig + 14.7 (Pa + 101325)

R = Gas constant for air,
1716.2 ft·lbf/slug·°R (286.9 J/kg·K)

For an isothermal flow for which the Mach number inside the pipe does not exceed 0.4, the pressure loss may be approximated as linear (i.e. constant pressure gradient). Therefore, the average density is given by:

$$\rho = \frac{P - \frac{1}{2} \Delta p}{R \cdot T} \quad \text{Eqn. (5)}$$

Combining Eqn. (1) - (5) yields:

$$\Delta p = \frac{\Psi \cdot R \cdot T}{P - \frac{1}{2} \Delta p} \quad \text{Eqn. (6)}$$

After solving and eliminating the extraneous root, the pressure loss can be expressed as:

$$\Delta p = P - \sqrt{P^2 - 2 \cdot \Psi \cdot R \cdot T}$$

Notes:

- The roughness coefficient, C , varies based on the pipe wall roughness - a function of the material. For Duratec pipe, a value of 150 is recommended.
- Duratec piping systems may be accurately sized to distribute various inert gases by inputting the correct Gas Constant, R , from Table 4 into Eqn. (4) and (7).

Example 1A

A sheet metal plant has an existing compressed air loop system operating at a pressure of 200 psig (1378951 Pa) and a temperature of 73 °F (22.8 °C). The system is now required to accommodate a new fabrication desk. The desk operates air tools that require an air flow rate of 7 ACFM (11.89 m3/hr). The maximum allowable air velocity is 20 ft/s (6.096 m/s).

If a new 200 ft (61 m) long Duratec® 1" compressed air branch line needs to be installed, calculate the total pressure drop in this new line. The line also contains 1 x Tee (branch flow), 1 x coupling, and 1 x 90° wingback fitting.

The pressure drop can be calculated using the modified Hazen-Williams relationship for air flows. The solution is as follows:

1. Calculate the line density of air using the ideal gas law:

$$\begin{aligned} \rho &= \frac{P}{R \cdot T} = \frac{214.7}{1716.2 \cdot 532.7} \cdot \left(\frac{144 \cdot \text{in}^2}{\text{ft}^2} \right) \\ &= 3.382 \times 10^{-2} \cdot \frac{\text{slug}}{\text{ft}^3} \end{aligned}$$

2. Calculate the mass flow rate of air:

$$\begin{aligned} M &= \rho \cdot Q = (0.03382) \cdot (7) \cdot \left(\frac{\text{min}}{60 \cdot \text{s}} \right) \\ &= 3.945 \times 10^{-3} \cdot \frac{\text{slug}}{\text{s}} \end{aligned}$$

3. Calculate the constant Ψ :

$$\begin{aligned} \Psi &= A_0 \cdot \left(\frac{4}{\pi \cdot C} \right)^n \cdot \left(\frac{T}{T_0} \right)^{s(2-n)} \cdot M^n \cdot \rho_0^{2-n} \cdot D^{-m-2n} \cdot g \cdot L \\ &= 5630 \cdot \left(\frac{4}{\pi \cdot 150} \right)^{1.848} \cdot \left(\frac{532.7}{519.7} \right)^{0.67(2-1.848)} \cdot (3.945 \times 10^{-3})^{1.848} \\ &\quad \cdot (2.373 \times 10^{-3})^{2-1.848} \cdot (1.032)^{-1.167-2(1.848)} \\ &\quad \cdot (32.17) \cdot (200) \cdot \left(\frac{\text{ft}^2}{144 \cdot \text{in}^2} \right) \\ &= 4.637 \times 10^{-4} \end{aligned}$$

4. Calculate the pipe pressure loss:

$$\begin{aligned}\Delta p &= P - \sqrt{P^2 - 2 \cdot \Psi \cdot R \cdot T} \\ &= 214.7 - \sqrt{(214.7)^2 - 2 \cdot (4.637 \times 10^{-4}) \cdot (1716.2) (532.7)} \\ &= 1.983 \cdot \text{psi}\end{aligned}$$

Therefore, the pressure loss in the 200 ft of pipe is 1.983 psi.

5. Determine the pressure loss due to the fittings for the given system conditions:

$$\Delta P_f = \sum_{i=1}^x P_{fi} \quad (\text{in ft})$$

According to Appendix B, Figure B1, the losses (in equivalent feet of pipe) are:

- 1 x 1" branch tee = 10 ft
- 1 x 1" coupling = 5 ft
- 1 x 1" 90° elbow = 10 ft

Therefore, the total loss due to the fittings is 25 ft of 1" pipe.

6. Calculate the total pressure loss due to the fittings in psi:

$$\begin{aligned}\Delta p_f &= \frac{(1.983 \cdot \text{psi})}{(200 \cdot \text{ft})} \cdot (25 \cdot \text{ft}) \\ &= 0.248 \cdot \text{psi}\end{aligned}$$

7. Combine the pipe and fittings losses to get the total system loss:

$$\begin{aligned}\Delta p_T &= 1.983 + 0.248 \\ &= 2.231 \cdot \text{psi}\end{aligned}$$

Therefore, the total pressure drop in the new line is 2.231 psi.

DETERMINING PRESSURE LOSS IN DURATEC AIR-LINE SYSTEMS USING PRESSURE DROP CHARTS

1. In order to use pressure drop charts, it is necessary to find the equivalent length of run from the compressor to the farthest point in the piping system. The reason is that the various pipe sizing charts are based on a pressure drop developed using friction loss for a given length of pipe. Measuring the actual length is the first step. In addition to the actual measured pipe length, the effect of fittings must be considered. This is because fittings create an obstruction to the flow of air. This degree of obstruction has been converted to an equivalent length of pipe in order to make calculations easy. Appendix B indicates the equivalent pipe length for fittings and valves, which should be added to the actual measured run to establish a total equivalent run.
2. Determine the actual pressure drop that will occur only in the piping system. Since the air compressor has not been selected yet, this figure is variable. A smaller pipe size may lead to higher compressor horsepower. It is considered good practice to oversize distribution mains to allow for future growth and the addition of condition equipment that may add a pressure drop not anticipated at the time of original design. It should be noted that this practice may result in a higher initial cost for the piping system.
3. Size the piping using the appropriate charts, having first calculated the flow rate at the operating pressure and operating temperature, scfm, and the allowable friction loss in each section of the piping being sized. Since all pipe sizing charts are calculated using loss of pressure per some length of piping (100 ft [30.5m]), it is necessary to arrive at the required value for the chart you are using.

**Figure 2 – Pressure Loss per 100 Feet of Duratec Pipe
Air at 160 psig (174.7 psia), 140°F**

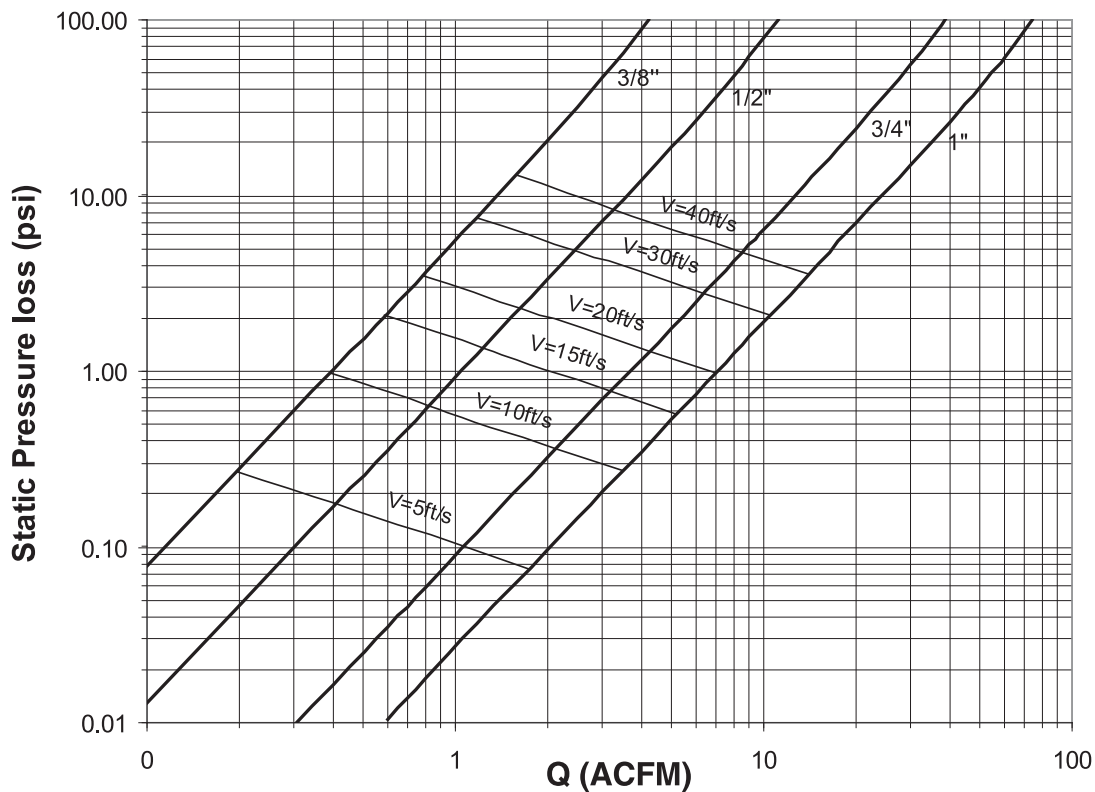

Consult Appendices B & C for various pressure loss charts at different temperatures.

Example 1B

An existing compressed air loop system operating at a system pressure of 200 psig (1378951.0 pag) and a system temperature of 73°F (22.78°C) is currently operational in a sheet metal plant.

The system is now required to accommodate a new fabrication desk. The fabrication desk operates compressed air tools that require a flow rate of 7 acfm (0.0033 m³/s) of air. The maximum allowable air velocity is 20 ft/s (6.096 m/s). If a new 200 ft (61 m) long Duratec 1" compressed air branch line needs to be installed, calculate the total pressure drop in this new line. The line contains 1 x Tee (branch flow), 1 x coupling and 1 x 90° wing back fitting.

Alternatively, to calculate the pressure drop in the Duratec pipe, pressure drop charts can be used. Please consult Appendix B for Pressure Loss charts at various gauge pressures and temperatures.

At the bottom of the chart mark off the system flow rate required (7 acfm).

Draw a line vertically upwards until you reach the maximum allowable air velocity (20 ft/s).

The pipe size at which the vertical line intersects below the diagonal maximum velocity line is the recommended pipe size (1").

From this point draw a horizontal line across the chart until it intersects the static pressure loss scale on the left hand side of the chart (0.99 psi per 100ft). Note this pressure loss is for 100 ft of pipe.

Calculate the Duratec pipe pressure losses by multiplying the static pressure loss from the chart by the pipe pressure losses = $\frac{0.99 \text{ psi}}{100 \text{ ft}} \times 200 \text{ ft} = 1.98 \text{ psi}$

Add the losses due to the fittings together. From Appendix B – Chart B1 it can be seen that the pressure drop for:

- 1 x 1" branch tee = 10 ft
- 1 x 1" coupling = 5 ft
- 1 x 1" 90° elbow = 10 ft
- Total losses due to fittings = 25 feet of 1" pipe

Calculate the Duratec fitting pressure losses by multiplying the static pressure loss from the chart by the total fitting pressure losses = $\frac{0.99 \text{ psi}}{100 \text{ ft}} \times 25 \text{ ft} = 0.2475 \text{ psi}$

Calculate the total pressure losses in the new system by adding the pipe losses to the fittings losses = 1.98 psi + 0.2475 psi = 2.2275 psi

Figure 3 – Pressure Loss per 100 feet of Duratec Pipe Air at 200 psig (214.7 psia), 73°F

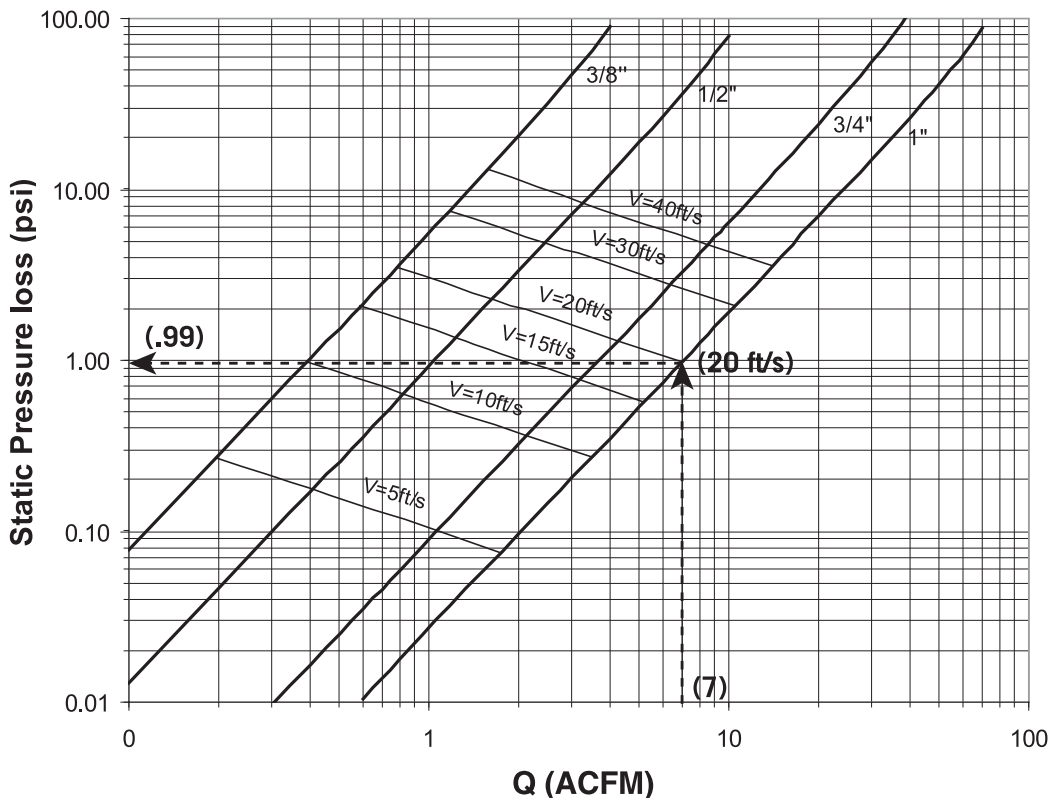

NOTES

SECTION FOUR: HANDLING AND INSTALLATION

Storage

Duratec pipe is shipped in protective cardboard boxes to maintain factory cleanliness. Boxes of Duratec pipe must be protected from the elements and stored indoors. Fittings are packaged and shipped in cardboard boxes and must also be stored indoors.

Fitting Installation

The Duratec fitting system is a compression-style fitting with a twist. We use a split ring that grips onto the outside of the pipe when the nut is tightened over the joint.

• Tools Required

Installation is simple and straightforward requiring only a pipe cutting tool, beveling tool and adjustable wrench. To install Duratec pipe and Duratec connector fittings, you may need the following: plastic pipe cutter, Duratec beveling tool, adjustable end wrench(es), suitable bending spring (optional).



• Procedures

Cutting and Joining Duratec:

1. Cut the pipe square.
A plastic pipe cutter should be used. Ensure that the stainless steel cutting blade being used is in good sharp condition.



2. Remove the nut and split ring from the fitting.
3. Push the nut and split ring onto the pipe. Bevel the inside of the pipe by inserting the Duratec beveling tool and rotating it 360° to engage the blades. The fitting will then slip easily into the pipe without displacing the o-rings.



4. Push the fitting onto the pipe. If necessary, at this point the fitting can be rotated on the pipe to facilitate the reading onto a valve, tee, etc.

Turn the nut finger tight, plus one full turn with a wrench.

Note: Overtightening the nut may cause damage to the pipe.



5. If it is necessary to remove the fitting, release the nut, remove the split ring and pull the fitting off the pipe. Before reassembling the joint, inspect the split ring and o-rings and replace them if necessary.

Cleaning Considerations with Industrial Grade Gaseous Oxygen

- The installation of pipe and fittings have the potential to leave swarf and debris in the piping system, therefore swarf and debris from handling and reaming must be removed before oxygen can be conveyed through the piping system.
- Duratec fittings may contain residual oils or grease used in the manufacturing process. therefore oil or grease must be removed before oxygen can be conveyed through the piping system.
- For further reference on cleaning pipe and fittings used in Industrial Grade Gaseous Oxygen service (IGGO), consult ASTM G 93 "Standard Practice for Cleaning Methods and Cleanliness Levels for Material and Equipment Used in Oxygen-Enriched Environments".

WARNING

Insufficient cleanliness of system components can promote ignition by mechanisms such as; pneumatic, mechanical, or particle impact and can result in explosive failures and cause severe injury or death.

Making a Threaded Connection

To make a Duratec threaded joint simply apply an IPEX recommended thread lubricant such as Teflon® tape (PTFE) or IPEX Thread Sealant to the threaded portion of the fitting.



If tape is used, wrap the tape around the entire length of threads beginning with number two thread from the end. The tape should slightly overlap itself going in the same direction as the threads. This will prevent the tape from unraveling when the fitting is tightened into a female adapter. Overlapping in the wrong direction and the use of too much tape can affect tolerances between threads. This can generate undue stress in the wall of female fittings.

If IPEX Thread Sealant is to be used, brush on a generous amount of sealant, using the correctly sized applicator, onto the threads beginning with the number two thread from the end.

IPEX Pipe Thread Compound has been specifically formulated for use with thermoplastic piping systems. Use of other sealants may contain substances harmful to thermoplastics.

Fittings should be threaded together until hand tight with an additional 1/2 to 1 turns more. Avoid stretching or distorting the fittings or threads by over tightening.

Pipe Supports

The lightweight design of Duratec continuous pipe coils allows for easy and quick installation. At the same time Duratec is quite rigid and maintains its shape when bent. Pipe supports should be provided every 8 feet 2 inches horizontally and vertically as a maximum lay length.

Duratec should not be rigidly anchored by a pipe support. Hangers and straps should provide for movement to avoid damage to the pipe. Hangers or straps with sharp or abrasive edges or that pinch the pipe should not be used.

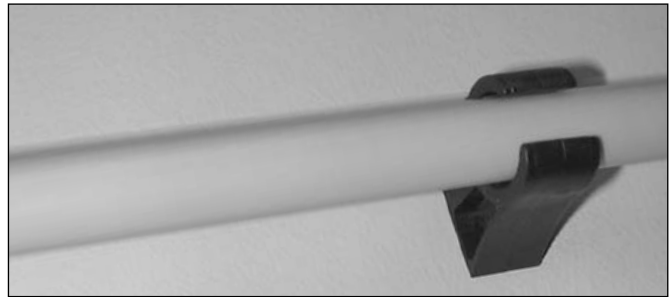

IPEX provides a specially designed Duratec clip for the hanging of Duratec pipe. The Duratec clip allows for the free pipe movement by minimizing friction between the pipe and clip. The Duratec clip has an efficient single point fixing with a snap-in design that allows for rapid installation. Several Duratec clips can be fixed in place and long coil lengths of pipe can be easily snapped into position.

Locate

Insert pipe into the open Duratec clip until it seats on the open jaws.

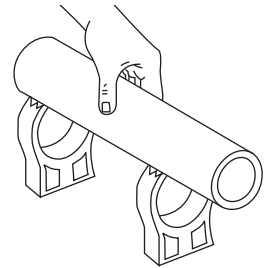

Snap In

Apply slight pressure to snap in pipe and force jaws to close and lock.

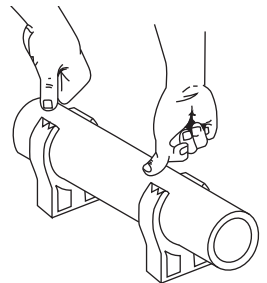

Retain

Fit retaining strap on clip sizes 1" and above.

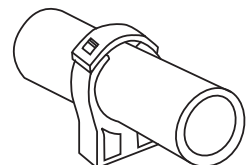

Bending Duratec Pipe

Duratec is easy to bend and unlike plastic pipes, retains its shape when bent. External bending springs and standard tube benders are available. Pipe in dimensions 3/8", 1/2" and 3/4" are easily bent by hand. For 1" pipe or if the bending radius is near the recommended limit of five (5) times the diameter of the pipe, a bending tool should be used.

Kinked, buckled, gouged or otherwise damaged pipe should not be used. Remove and replace any damaged sections.



Quick Release Coupling Connections

Quick release couplings or hoses may be connected into the Duratec Air-Line system by means of a female threaded adapter. In this case it is recommended that the connection should be reinforced using two pipe clips as illustrated.

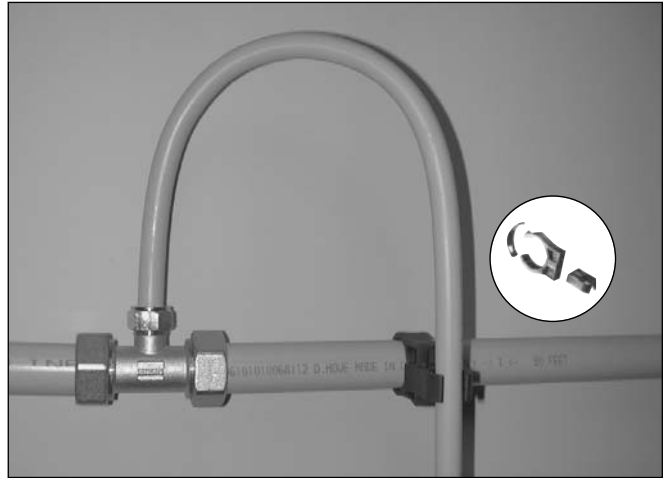

It is important to install the T drop in the vertical position and loop the leg upwards before bringing it down to the drop. This will prevent the transfer of moisture and contaminants into the work stations.

Electrical Grounding

Duratec systems should not be used to ground an electrical system. Although Duratec contains an aluminum core, its joining system is not designed to provide electrical continuity.

Testing Duratec Systems

Testing of Duratec can take place immediately upon installation, since the joining procedure does not require a curing time.

The purpose of a site pressure test is to establish that all joints have been correctly made before commissioning the system. **(Always air test in accordance with the authority having jurisdiction.)**

After making the first 20 or 30 joints, it is recommended that a test be applied to prove that the joint-making technique is satisfactory. If a leak is discovered, follow the appropriate procedure below.

The pressure testing procedure detailed below should be strictly followed.

1. Fully inspect the installed piping for evidence of mechanical abuse and suspect joints.
2. Split the system into convenient test sections, not exceeding 1,000 feet. The piping should be capped off with a Duratec cap at the end of the pipe section to be tested.
3. Test Duratec to a maximum of 1.25 times the design operating pressure. Duration of testing shall comply with local regulatory measures or alternatively with the engineer designing and inspecting the system, however this should not exceed 2 hours.
4. If there is a significant drop in pressure, or extended times are required to achieve the desired pressure, a joint leakage has occurred. In this event inspect for joint leaks.
5. If joints are leaking, tighten the nut 1/8 to 1/4 turn.
6. Repeat step 3 after repairing any leaking joints.

Exposure to Sunlight

Duratec pipe contains UV stabilizers and antioxidants that provide protection against UV degradation for a period of up to 2 years continuous exposure in southern climates such as Florida. For long term exposure >2 years, IPEX recommends permanently shielding the pipe from UV radiation. Duratec pipe can be painted with a water-based latex paint.

Burial

Duratec pipe is suitable for direct burial applications as well as encasement in concrete. No additional protective sleeving is required unless entering or exiting a concrete slab. If Duratec D1 fittings are to be buried, a protective heat shrink sleeve must be used to protect the fittings.

SECTION FIVE: DIMENSIONAL DATA

DIMENSIONAL DATA

Pipe

Nominal Pipe Size	Average O.D. (in.)	Average I.D. (in.)	Coil Lengths (ft.)
3/8"	0.480	0.345	100/300
1/2"	0.630	0.500	100/300
3/4"	0.980	0.805	100/300
1"	1.260	1.030	100/300

Tee

Size	A (in.)	B (in.)	A2 (in.)	B2 (in.)
3/8"	0.945	0.472	1.142	0.571
1/2"	1.205	0.583	1.346	0.654
3/4"	1.880	1.005	2.140	1.130
1"	1.510	0.765	1.675	0.845

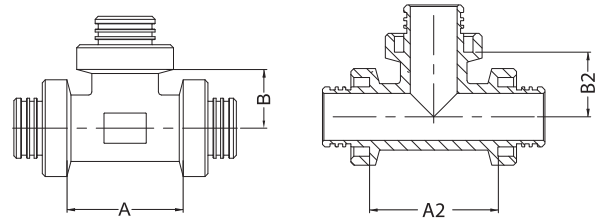

Reducer Tee

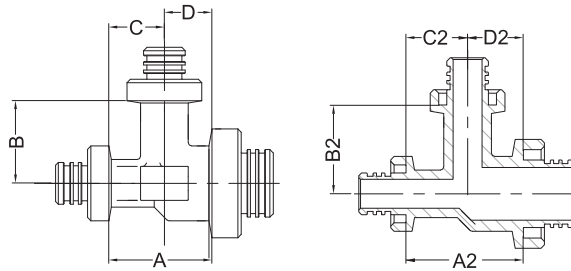

Size	A (in.)	B (in.)	C (in.)	D (in.)	A2 (in.)	B2 (in.)	C2 (in.)	D2 (in.)
1/2" x 1/2" x 3/8"	0.945	0.550	0.470	0.470	1.140	0.650	0.570	0.570
3/4" x 1/2" x 1/2"	1.195	0.955	0.645	0.550	1.360	1.025	0.715	0.645
3/4" x 1/2" x 3/4"	1.430	0.750	0.675	0.750	1.600	0.840	0.745	0.855
3/4" x 3/4" x 1/2"	1.250	0.790	0.625	0.625	1.435	0.875	0.720	0.720
1" x 3/4" x 3/4"	1.690	1.140	0.750	0.940	1.905	1.235	0.840	1.065
1" x 1" x 1/2"	1.760	0.905	0.880	0.880	2.025	0.985	1.010	1.010
1" x 1" x 3/4"	1.640	0.980	0.820	0.820	1.900	1.075	0.950	0.950

Tee Adapter

Size	A (in.)	B (in.)	A2 (in.)	B2 (in.)
1/2" x 1/2" x 1/2"	1.175	0.710	1.320	0.395

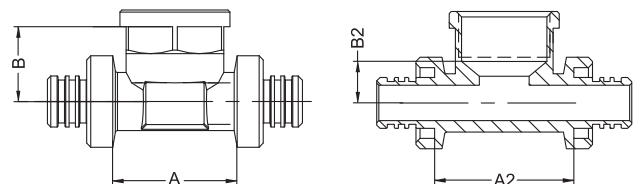

90° Drop Ear Elbow (D1 x Female NPT)

Size	A (in.)	B (in.)	C (in.)	D (in.)	E (in.)
1/2" x 1/2"	0.630	0.715	0.695	0.530	0.535

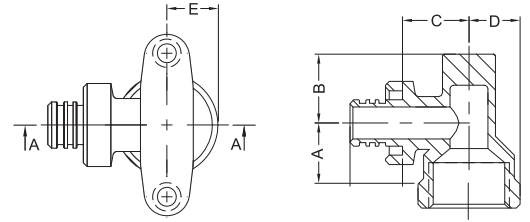

Coupling

Size	A (in.)	A2 (in.)
3/8"	0.355	0.470
1/2"	0.355	0.475
3/4"	0.395	0.455
1"	0.395	0.530

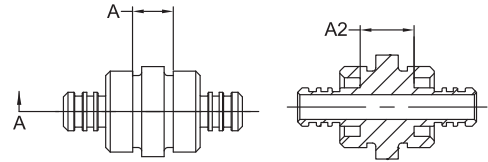

Reducer Coupling

Size	A (in.)	A2 (in.)
1/2" x 3/8"	0.355	0.455
3/4" x 1/2"	0.375	0.465
1" x 3/4"	0.375	0.470

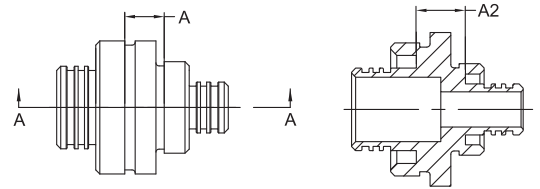

Male Adapter (D1 x Male NPT)

Size	A (in.)	B (in.)	A2 (in.)
3/8" x 1/4"	0.270	0.195	0.330
3/8" x 3/8" *	0.270	0.195	0.330
3/8" x 1/2" *	0.275	0.195	0.335
1/2" x 1/2" *	0.280	0.195	0.340
3/4" x 3/4" *	0.290	0.195	0.320
1" x 1" *	0.295	0.195	0.360

* also available in stainless steel

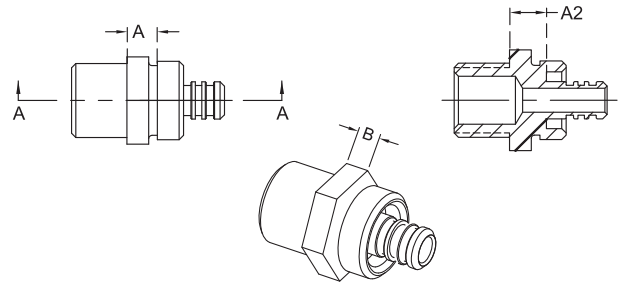

Female Adapter (D1 x Female NPT)

Size	A (in.)	B (in.)	A2 (in.)
3/8"	0.280	0.195	0.240
1/2"	0.270	0.195	0.260
3/4"	0.295	0.195	0.230
1"	0.295	0.195	0.195

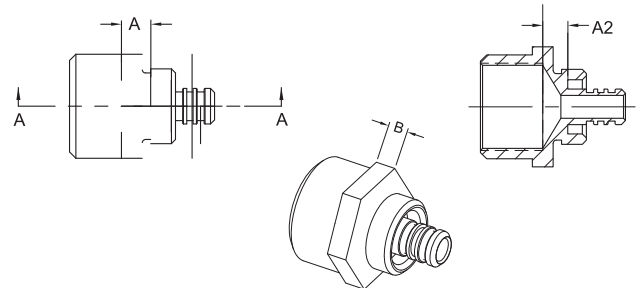

Cap

Size	A (in.)	A2 (in.)
3/8"	0.280	0.340
1/2"	0.280	0.340
3/4"	0.380	0.415
1"	0.382	0.445

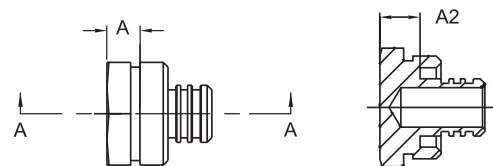

Ball Valve

Size	L (in.)	A (in.)	B (in.)	C (in.)
3/8"	1.420	2.630	1.650	3.700
1/2"	1.610	2.980	1.810	3.900
3/4"	1.680	3.250	2.200	4.250
1"	2.050	3.780	2.620	4.920

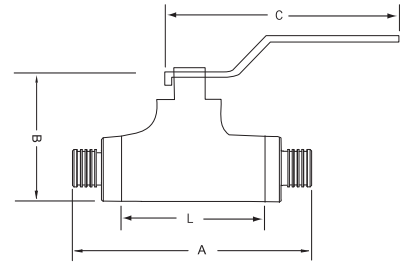

D1 x Tube Adapter Fittings

Size	A (in.)	B (in.)	C (in.)
3/8" x 1/4"	0.630	0.250	0.035
3/8" x 3/8"	0.690	-	0.035
1/2" x 1/2"	0.910	0.500	0.049
3/4" x 3/8"	0.970	0.750	0.065
1" x 1"	1.220	1.000	0.065

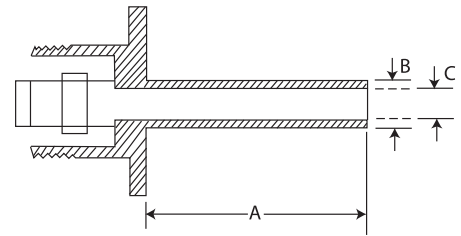

Duratec Clips

Size	A (in.)	B (in.)	C (in.)	G (in.)	Screw/Bolt Size	Wgt (oz)
1/2"	-	1.380	0.980	0.630	#8 / 5/32 / M4	0.250
3/4"	-	1.380	1.380	0.690	#10 / 1/4 / M5	0.390
1"	-	1.570	1.571	0.690	#10 / 1/4 / M5	0.490

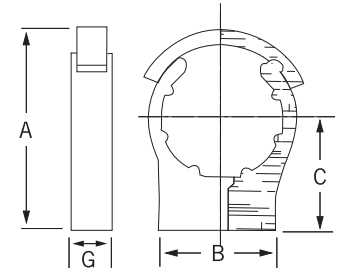

1. Clips of size 1" and above are fitted with retaining strap.
2. Use machine, tapping or wood screws with flat or oval head.
Use bolts to suit clip recess.

O-Ring

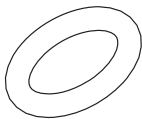

Size
3/8"
1/2"
3/4"
1"

Compression Ring



Size
3/8"
1/2"
3/4"
1"

Compression Nut

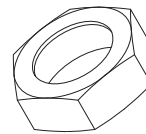

Size
3/4"
1/2"
3/4"
1"

NOTES

SECTION SIX: SPECIFICATIONS

Short Form Specification

This specification sheet covers the manufacturer's requirements for PE-AL-PE composite pressure pipe and associated metallic fittings for use in compressed air and inert gas piping systems. The pipe and fittings meet or exceed all applicable ASTM, CSA and OSHA standards.

Duratec Pipe Materials

High density polyethylene (HDPE) and aluminum used in the manufacture of Duratec pipe shall meet the requirements of ASTM F1282 and CSA B137.9.

HDPE raw materials used in the inner and outer layers of Duratec pipe shall be of Grade PE33 as per ASTM D3350 and shall contain defined amounts of color pigment, stabilizers and other basic additives. The HDPE shall have a hydrostatic design stress of 630 psi for water at 73°F.

The outer pipe layer of HDPE shall include UV stabilizer that imparts resistance equivalent to 2 years of continuous outdoor exposure in Florida as evidenced in the manufacturer's material specifications.

The inner pipe layer of HDPE shall be resistant to commonly used synthetic and natural compressor oils as evidenced in the manufacturer's chemical resistance testing.

PE-AL-PE pipe shall meet the health and safety requirements of OSHA as evidenced by the manufacturer's testing.

Duratec Fitting Materials

Duratec brass fittings shall meet the requirements of ASTM F1974 and CSA B137.9. Fittings shall have an additional protective nickel plating to provide resistance to potentially corrosive industrial environments.

Stainless steel Duratec fittings shall meet the dimensional and performance requirements of ASTM F1974 and CSA B137.9, and shall be made with UNS S31600 stainless steel.

Dimensions

Physical dimensions and properties of Duratec PE-AL-PE composite pipe shall meet or exceed the requirements of ASTM F1282 and CSA B137.9.

Physical dimensions and properties of Duratec brass fittings and stainless steel fittings shall meet the requirements of ASTM F1974 and CSA B137.9.

Marking

Duratec pipe is marked as prescribed in ASTM F1282 and CSA B137.9. The marking is contrasting green in color and includes the following: Duratec, IPEX, PE-AL-PE, nominal pipe size, pressure ratings at 73°F and 140°F and date coding.

Duratec fittings are marked with the name Duratec and the applicable ASTM and CSA standard.

Sample Specification

All compressed air and inert gas pipe in sizes 1" and smaller shall be PE-AL-PE composite pipe made with high density polyethylene and aluminum conforming to ASTM F1282 and CSA B137.9. PE-AL-PE pipe shall meet the health and safety requirements of OSHA.

All compressed air and inert gas fittings in sizes 1" and smaller shall be nickel plated brass or 316 stainless steel and shall conform to the dimensional and physical requirements of ASTM F1974 and CSA B137.9.

All pipe, fittings and accessories shall be Duratec Air-Line as manufactured by IPEX.

NOTES

SECTION SEVEN: APPENDICES

APPENDIX A - GLOSSARY

Compressed Air System Glossary

Air Flow Volume of free air in CFM.

Air Receiver Tank Tank used for compressed air storage.

Artificial Demand Additional air consumption caused by excessive system pressure.

Capacity The amount of air flow delivered or required under some specific conditions. May be stated as ACFM, SCFM, or CFM FAD.

Cubic feet of air per minute (CFM) Volume delivery rate of air flow.

Cubic feet of air per minute, free air (CFM FA) CFM of air delivered to some specific point and converted back to ambient air (free air) conditions.

Actual cubic feet per minute (ACFM) Flow rate of air measured at some reference point and based on actual conditions at that reference point.

Inlet cubic feet per minute (ICFM) CFM flowing through the compressor inlet filter or inlet valve under rated conditions.

Standard cubic feet per minute (SCFM) Flow of free air measured at a reference point and converted to a standard set of reference conditions (e.g., 14.7 PSIA, 60°F, and 0% relative humidity).

Compressed Gas Any gas stored or distributed at a pressure greater than atmospheric pressures (14.7 psi or 101.4KPa).

Demand Flow of air under specific conditions required at a particular point.

Discharge Pressure, rated Air pressure produced at a reference point.

Discharge Pressure, required Air pressure required at the system inlet.

Dual Control Load/unload control system that maximizes compressor efficiency. Compressor is normally operated at full load or idle, and is stopped and restarted automatically depending on demand.

Duty Cycle Percentage of time a compressor unit can operate at full load over a thirty minute period.

Flow Meter An instrument used to measure flow rate, pressure, vapor, or gas flowing through a pipe.

Load Factor Ratio of the average compressor load to the maximum rated compressor load during a given period of time.

Modulating Control Control system which will run the compressor at reduced output to accommodate demand variations. Running a compressor at less than full load results in a drop in compressor efficiency and thus an increase in operating costs.

Pressure Force per unit area.

Pounds per square inch (PSI) Force per unit area exerted by compressed air.

Pounds per square inch absolute (PSIA) Absolute pressure above zero pressure.

Pounds per square inch gauge (PSIG) Pressure difference between absolute pressure (PSIA) and ambient pressure.

Pounds per square inch differential (PSID) Pressure difference between two defined points in the system.

Pressure Dew Point Temperature at which water will begin to condense out of air at a given pressure. To ensure that no liquid water is present, the pressure dew point must be less than the lowest temperature to which the compressed air will be exposed.

Pressure Drop Loss of pressure in a compressed air system due to friction or flow restriction.

Conversion Glossary

	MULTIPLY	BY	TO OBTAIN
Volume	cubic feet/minute gallons liters/minute cubic meters	0.472 0.134 0.264 35.315	liter/second cubic feet gallons/minute cubic feet
Pressure	inches mercury inches water PSI bar	0.491 25.400 27.680 14.504	PSI mm water inches water PSI
Density	pint water gallon water pounds water	1.042 8.336 7000	pounds water pounds water grains water
Power	horsepower horsepower	0.745 2544.430	kilowatts BTU/hour
Temperature	degrees Fahrenheit	(degrees - 32) x .556	degrees Centigrade

APPENDIX B - PRESSURE LOSS CHARTS (ACFM)

Figure B1
Pressure Loss per 100 Feet of Duratec Pipe
Air at 200 psig (214.7 psia), 73°F

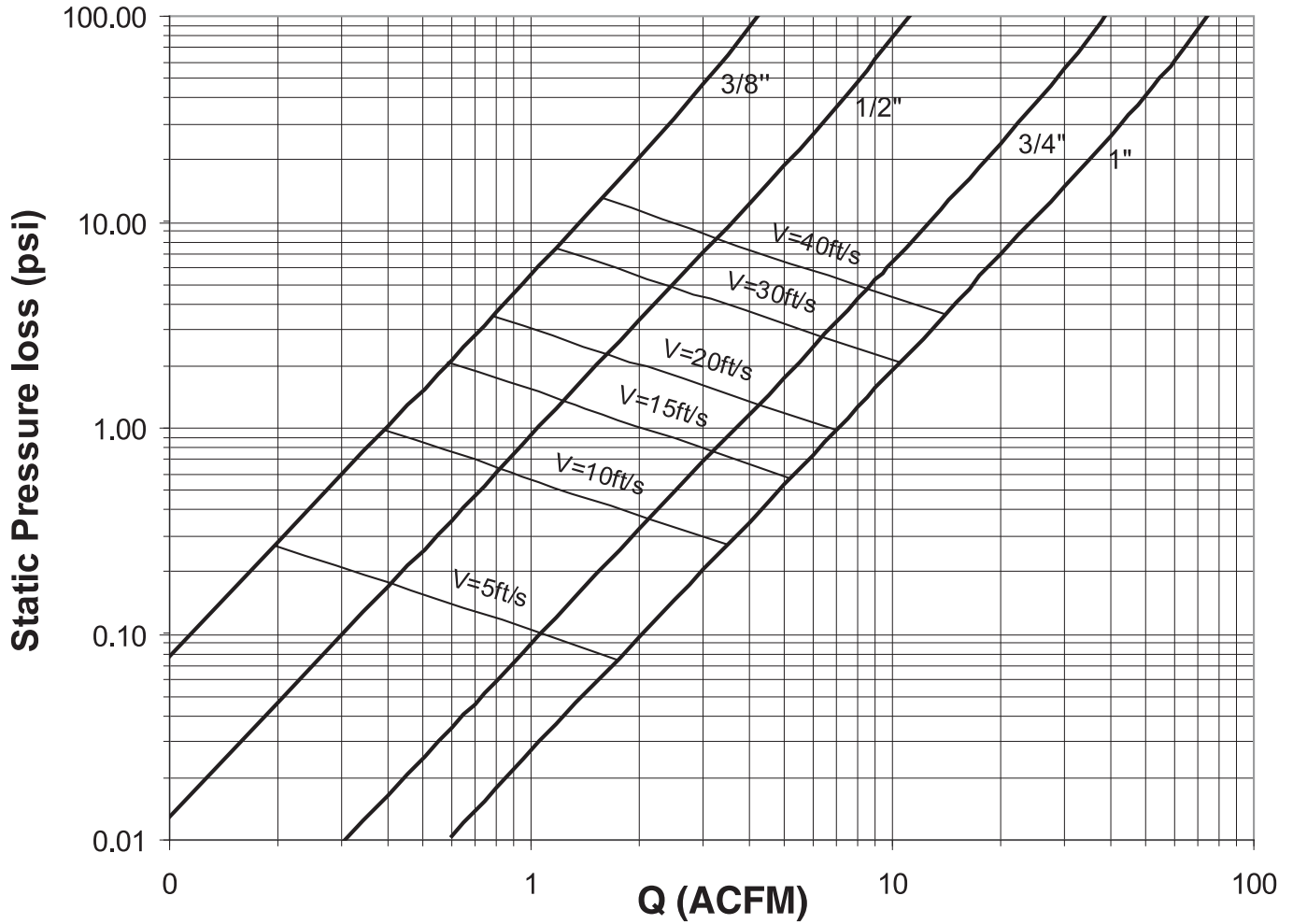

Pressure Loss through Duratec Fittings
in Equivalent Feet of Pipe

Size	Fitting	Velocity (fps) 200 psi @ 73°F					
		5	10	15	20	30	40
3/8"	Straight	1	1	2	2	2	2
	Tee Branch, Elbow	3	4	4	4	4	5
1/2"	Straight	1	2	2	2	3	3
	Tee Branch, Elbow	4	5	5	6	6	6
3/4"	Straight	2	3	4	4	4	4
	Tee Branch, Elbow	6	7	8	8	9	9
1"	Straight	4	4	5	5	5	6
	Tee Branch, Elbow	7	8	9	10	10	11

Straight = coupler, thread adapter, tee run

Figure B2
Pressure Loss per 100 Feet of Duratec Pipe
Air at 160 psig (174.7 psia), 140°F

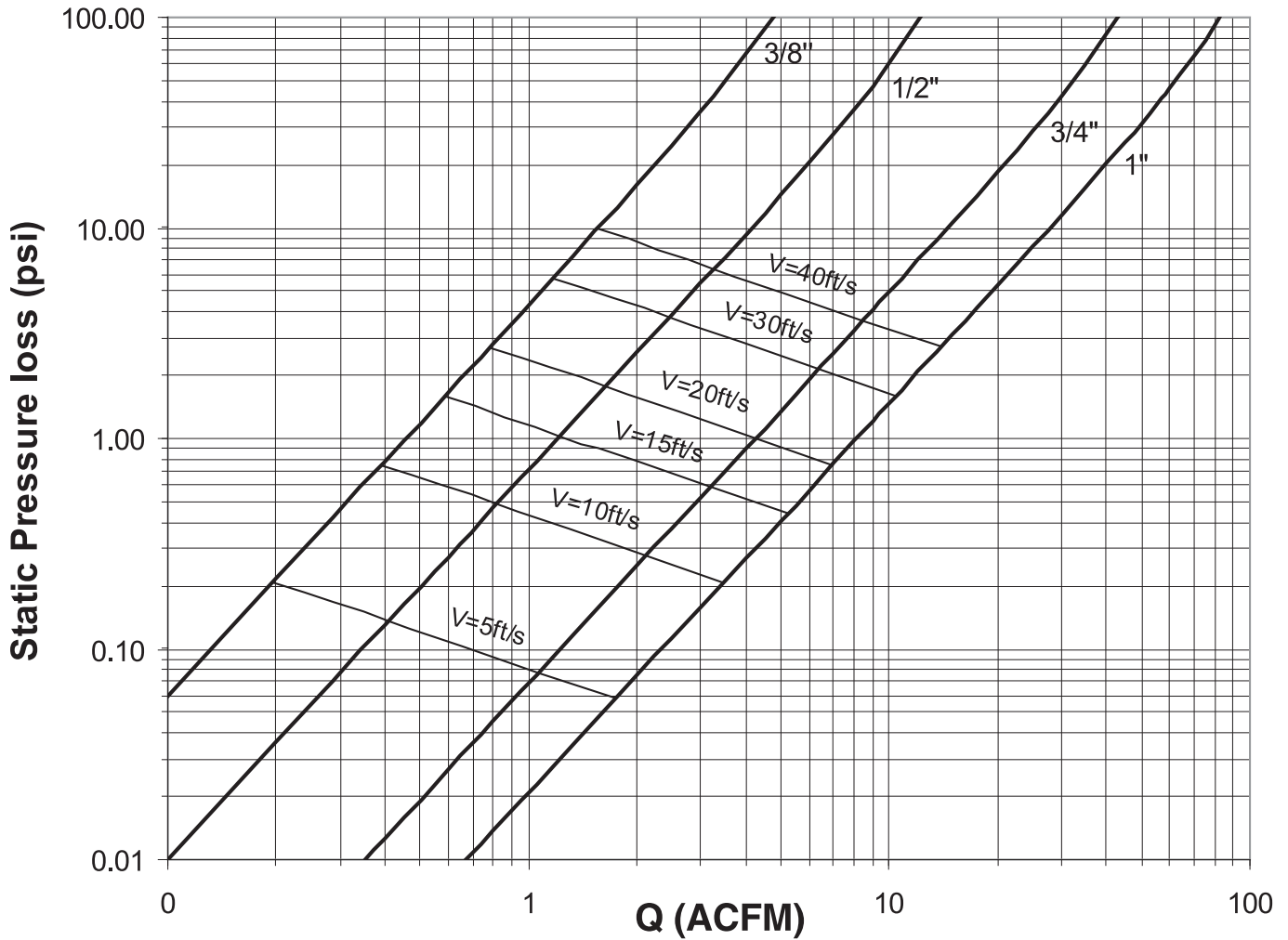

Pressure Loss through Duratec Fittings
in Equivalent Feet of Pipe

Size	Fitting	Velocity (fps) 160 psi @ 140°F					
		5	10	15	20	30	40
3/8"	Straight	1	1	2	2	2	2
	Tee Branch, Elbow	3	3	4	4	4	4
1/2"	Straight	1	2	2	2	2	2
	Tee Branch, Elbow	4	5	5	5	6	6
3/4"	Straight	3	3	3	3	4	4
	Tee Branch, Elbow	6	7	7	8	8	9
1"	Straight	3	4	5	5	5	5
	Tee Branch, Elbow	7	8	8	9	10	10

Straight = coupler, thread adapter, tee run

Figure B3
Pressure Loss per 100 Feet of Duratec Pipe
Air at 40 psig (54.7 psia), 60°F

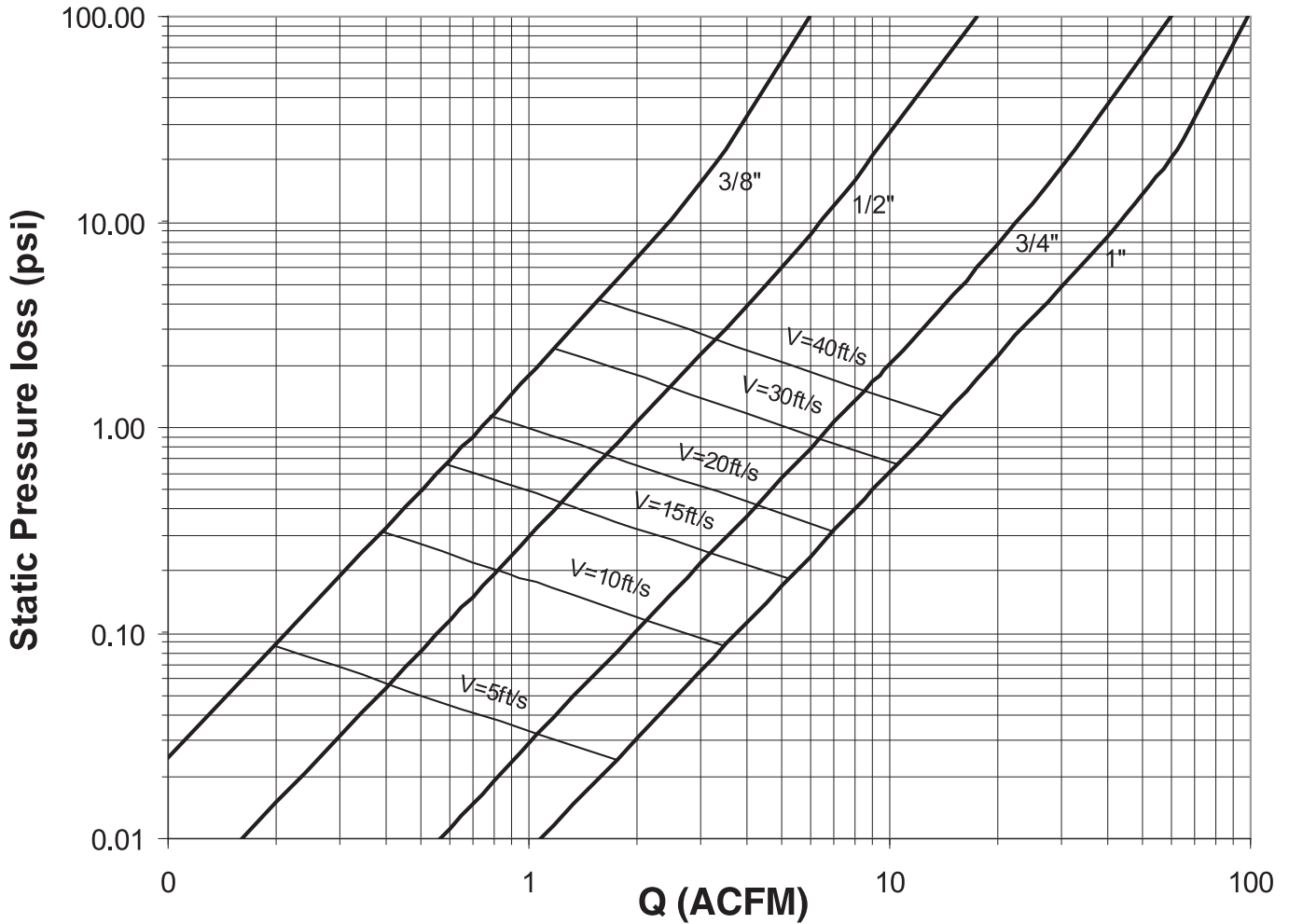

Pressure Loss through Duratec Fittings
in Equivalent Feet of Pipe

Size	Fitting	Velocity (fps) 40 psi @ 60°F					
		5	10	15	20	30	40
3/8"	Straight	1	1	1	1	1	1
	Tee Branch, Elbow	2	3	3	3	3	4
1/2"	Straight	1	1	2	2	2	2
	Tee Branch, Elbow	2	3	4	4	5	5
3/4"	Straight	1	2	3	3	3	3
	Tee Branch, Elbow	4	5	6	6	7	7
1"	Straight	3	3	3	4	4	5
	Tee Branch, Elbow	5	6	7	7	8	9

Straight = coupler, thread adapter, tee run

Figure B4
Pressure Loss per 100 Feet of Duratec Pipe
Air at 80 psig (94.7 psia), 60°F

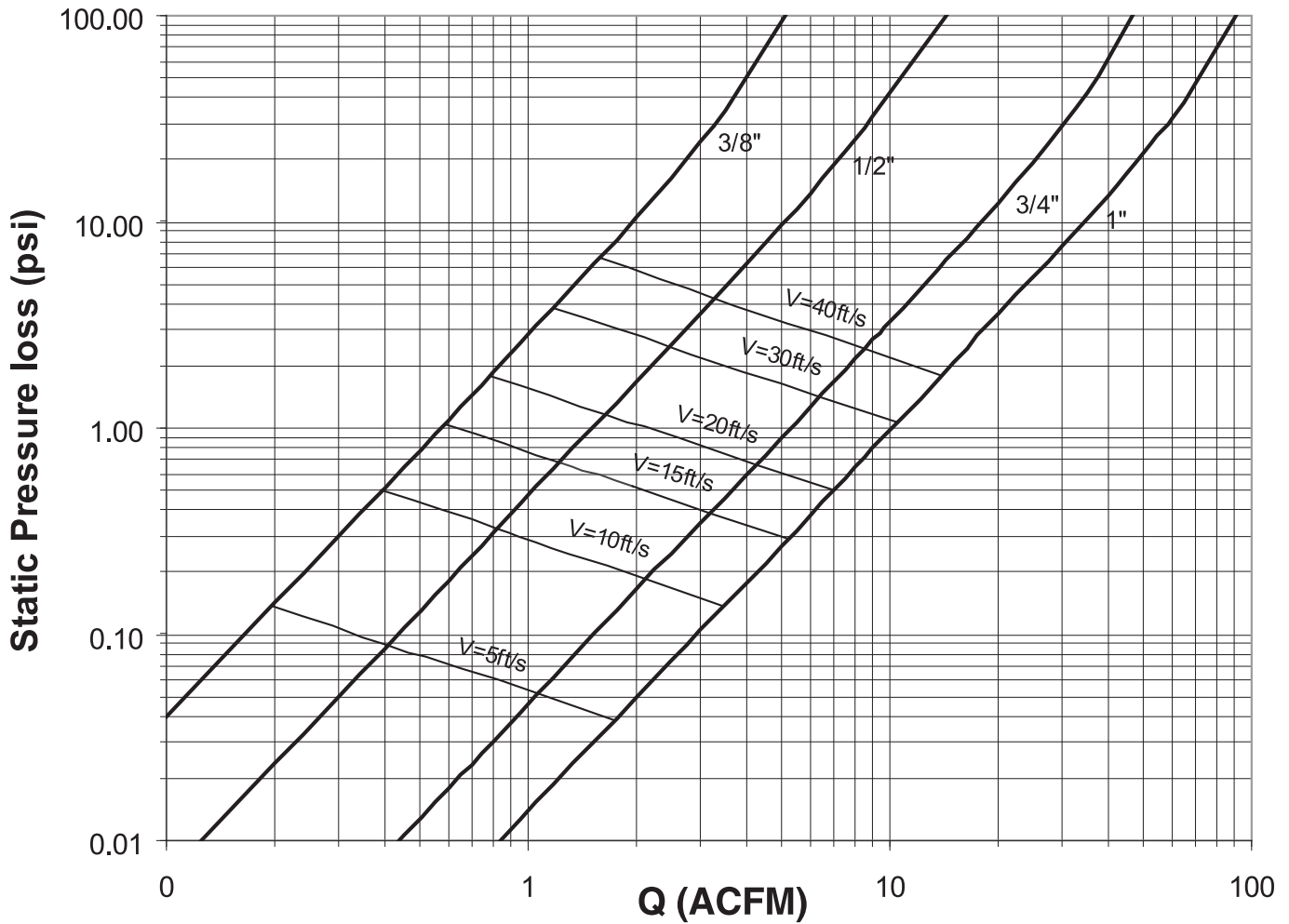

Pressure Loss through Duratec Fittings
in Equivalent Feet of Pipe

Size	Fitting	Velocity (fps) 80 psi @ 60°F					
		5	10	15	20	30	40
3/8"	Straight	1	1	1	1	1	2
	Tee Branch, Elbow	2	3	3	4	4	4
1/2"	Straight	1	2	2	2	2	2
	Tee Branch, Elbow	3	4	4	5	5	5
3/4"	Straight	2	3	3	3	4	4
	Tee Branch, Elbow	5	6	7	7	8	8
1"	Straight	3	4	4	4	5	5
	Tee Branch, Elbow	6	7	8	8	9	10

Straight = coupler, thread adapter, tee run

Figure B5
Pressure Loss per 100 Feet of Duratec Pipe
Air at 120 psig (134.7 psia), 60°F

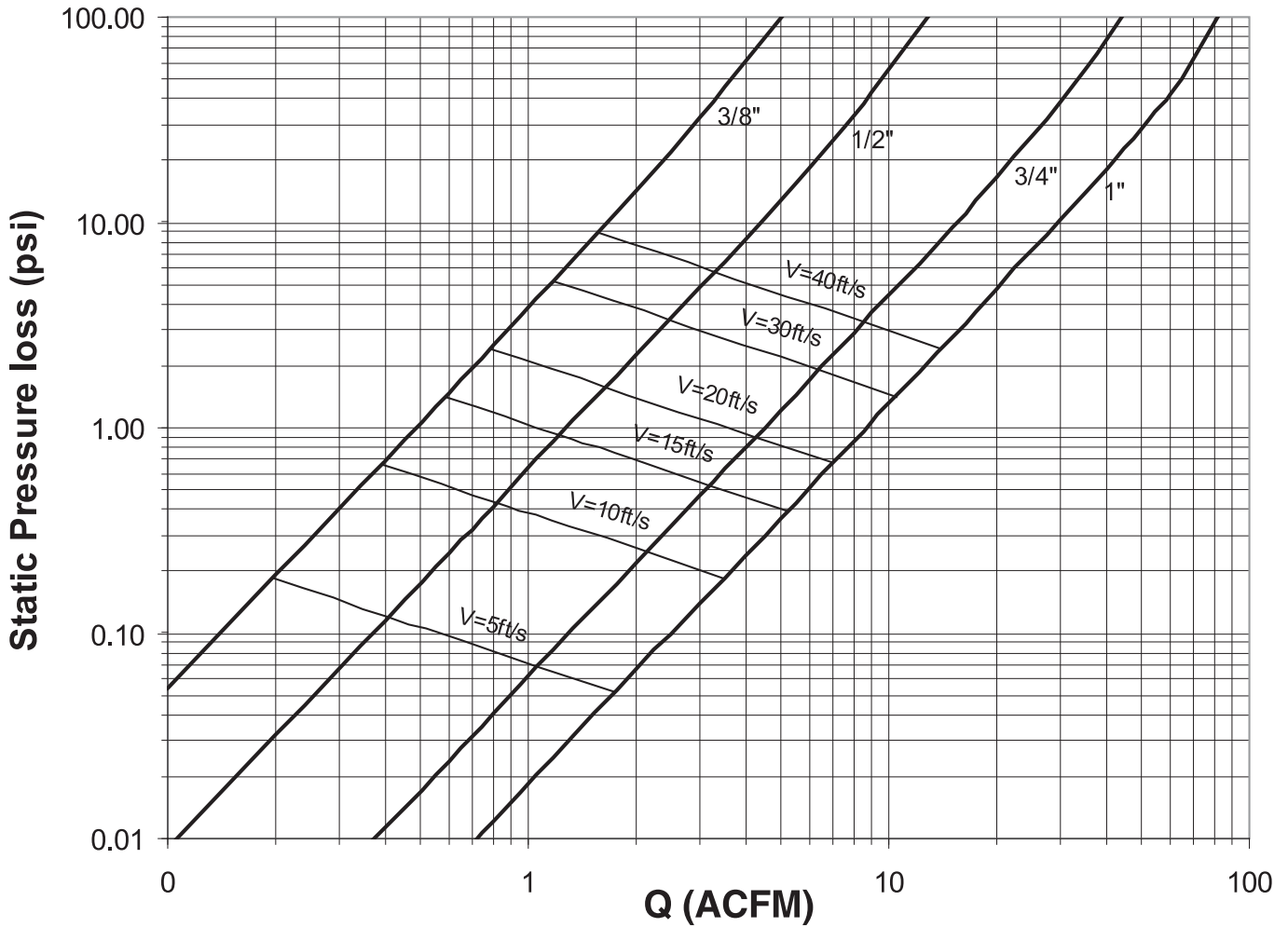

Pressure Loss through Duratec Fittings
in Equivalent Feet of Pipe

Size	Fitting	Velocity (fps) 120 psi @60°F					
		5	10	15	20	30	40
3/8"	Straight	1	1	2	2	2	2
	Tee Branch, Elbow	3	3	4	4	4	4
1/2"	Straight	1	1	2	2	2	2
	Tee Branch, Elbow	3	4	5	5	6	6
3/4"	Straight	2	3	3	4	4	4
	Tee Branch, Elbow	6	7	7	8	8	9
1"	Straight	3	4	4	5	5	5
	Tee Branch, Elbow	7	8	8	9	10	10

Straight = coupler, thread adapter, tee run

Figure B6
Pressure Loss per 100 Feet of Duratec Pipe
Air at 160 psig (174.7 psia), 60°F

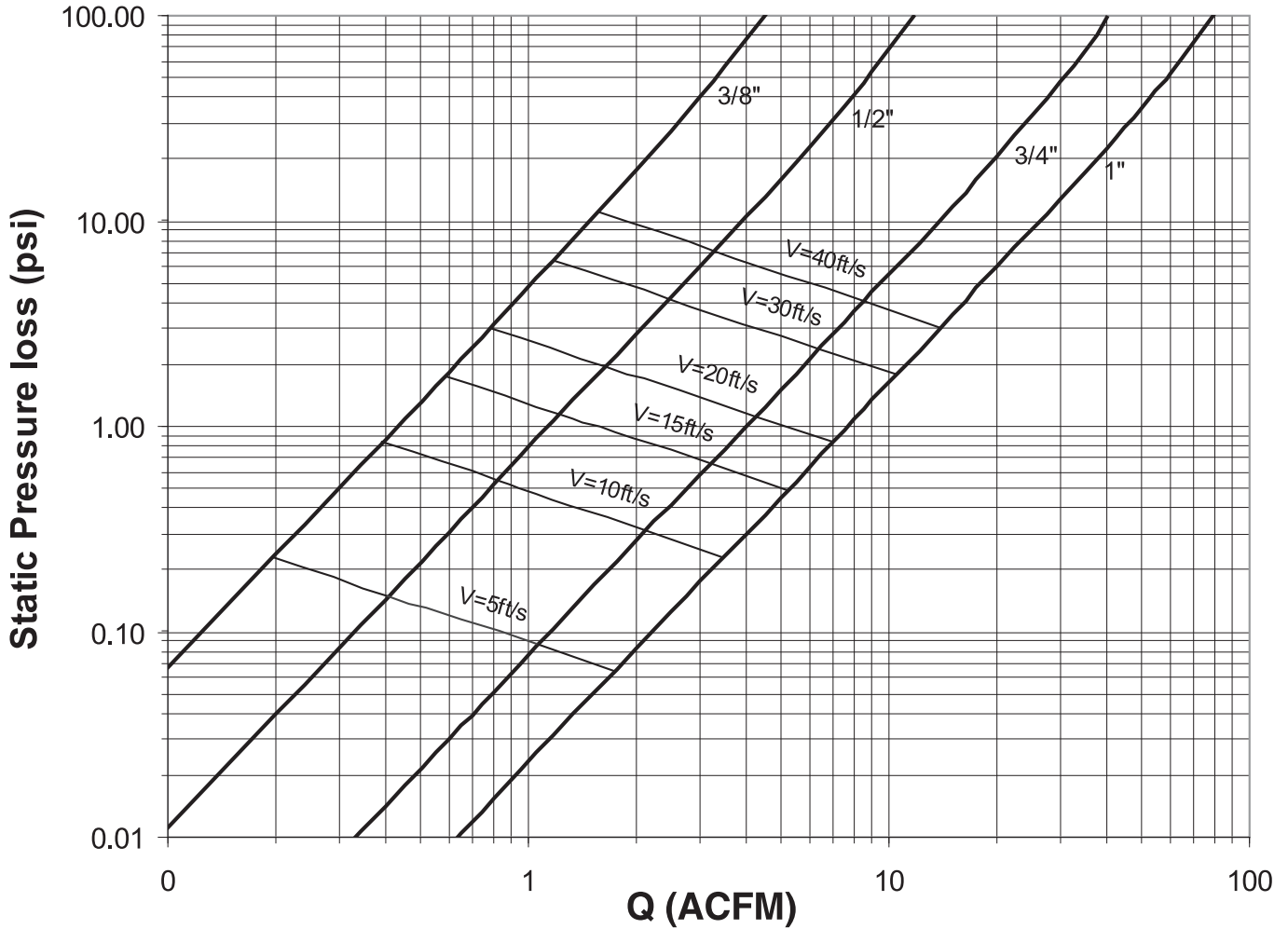

Pressure Loss through Duratec Fittings
in Equivalent Feet of Pipe

Size	Fitting	Velocity (fps) 160 psi @ 60°F					
		5	10	15	20	30	40
3/8"	Straight	1	1	2	2	2	2
	Tee Branch, Elbow	3	4	4	4	4	4
1/2"	Straight	2	2	2	2	2	3
	Tee Branch, Elbow	4	5	5	5	5	6
3/4"	Straight	3	3	4	4	4	4
	Tee Branch, Elbow	6	7	8	8	9	9
1"	Straight	4	4	5	5	5	5
	Tee Branch, Elbow	7	8	9	9	10	11

Straight = coupler, thread adapter, tee run

Figure B7
Pressure Loss per 100 Feet of Duratec Pipe
Air at 200 psig (214.7 psia), 60°F

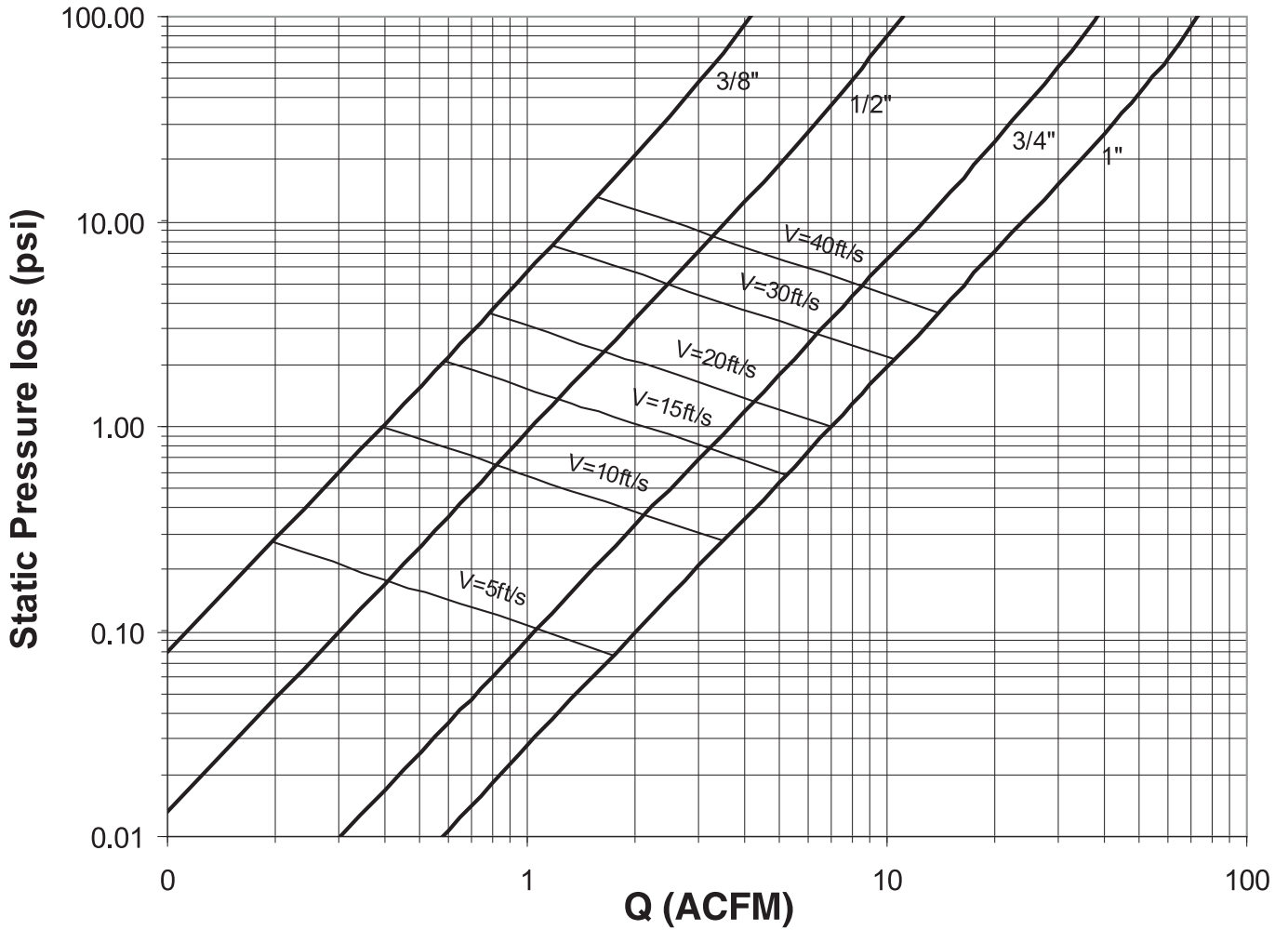

Pressure Loss through Duratec Fittings
in Equivalent Feet of Pipe

Size	Fitting	Velocity (fps) 200 psi @ 60°F					
		5	10	15	20	30	40
3/8"	Straight	1	2	2	2	2	2
	Tee Branch, Elbow	3	4	4	4	4	5
1/2"	Straight	2	2	2	2	3	3
	Tee Branch, Elbow	4	5	5	6	6	6
3/4"	Straight	3	3	4	4	4	4
	Tee Branch, Elbow	6	7	8	9	9	9
1"	Straight	4	4	5	5	5	6
	Tee Branch, Elbow	8	8	9	10	10	11

Straight = coupler, thread adapter, tee run

APPENDIX C - PRESSURE LOSS CHARTS (SCFM)

Figure C1
Pressure Loss per 100 Feet of Duratec Pipe
Air at 40psig (54.7psia), 60°F

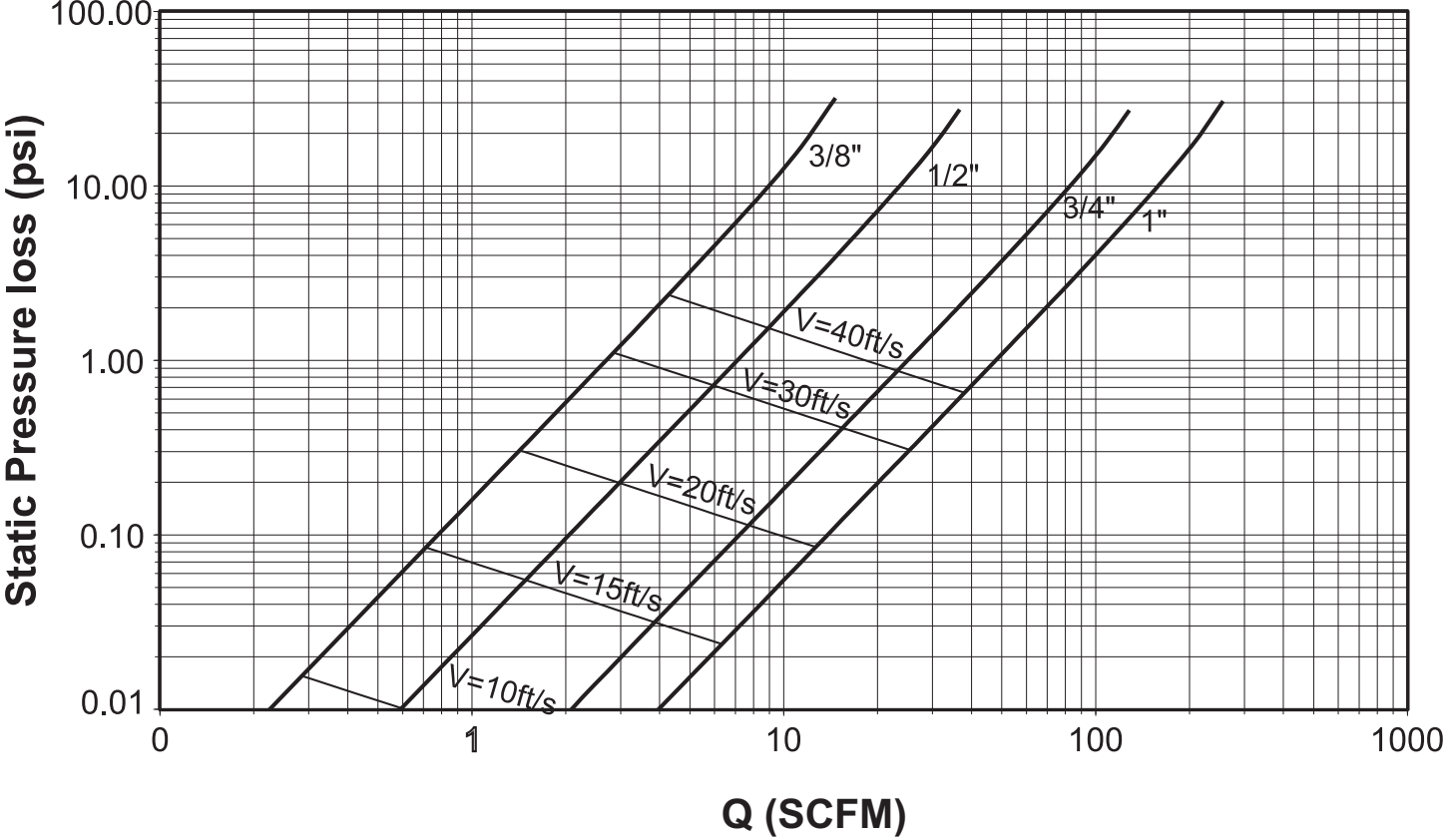

Figure C2
Pressure Loss per 100 Feet of Duratec Pipe
Air at 80psig (94.7psia), 60°F

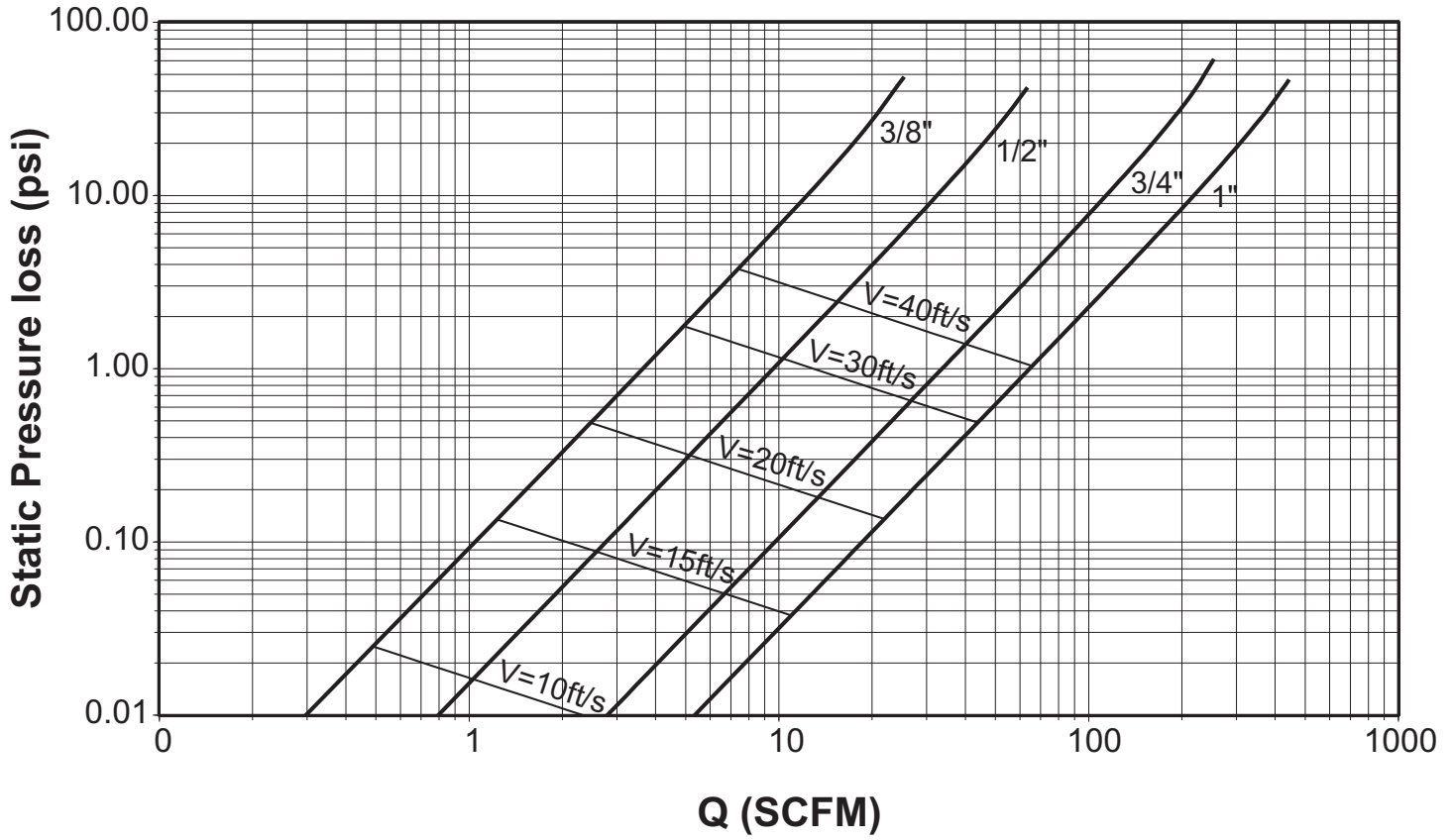

Figure C3
Pressure Loss per 100 Feet of Duratec Pipe
Air at 120psig (134.7psia), 60°F

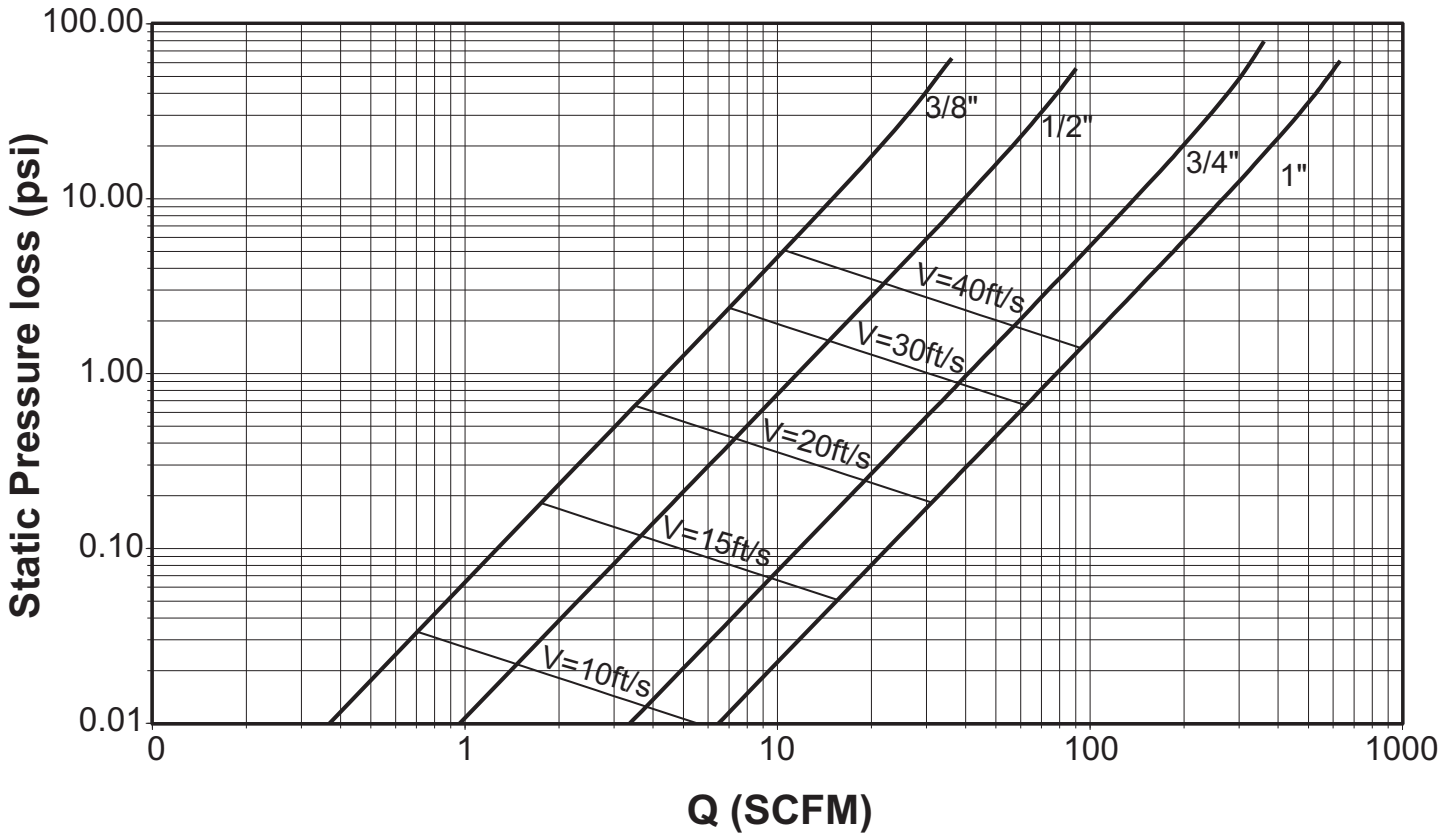

Figure C4
Pressure Loss per 100 Feet of Duratec Pipe
Air at 160psig (174.7psia), 60°F

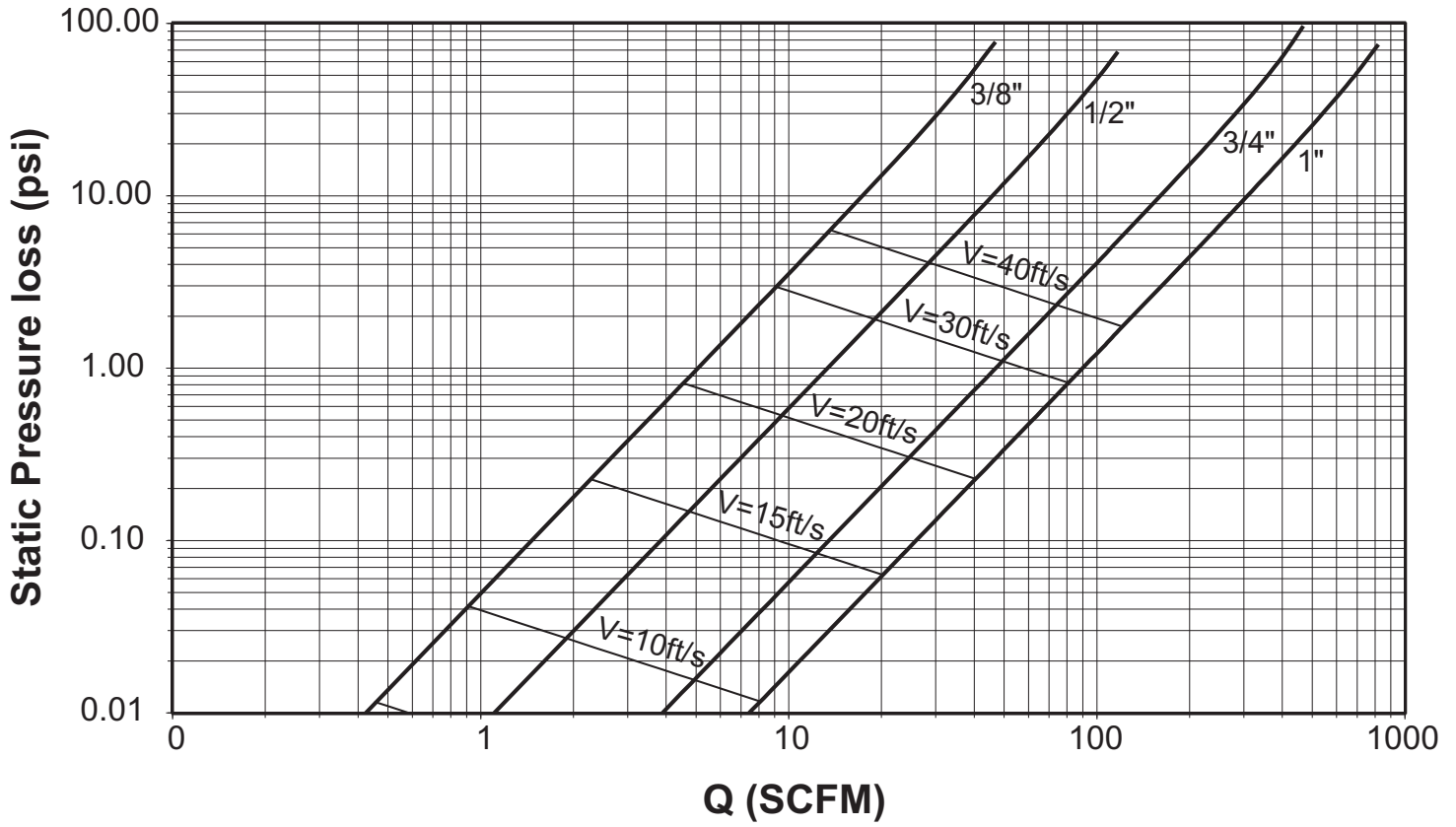
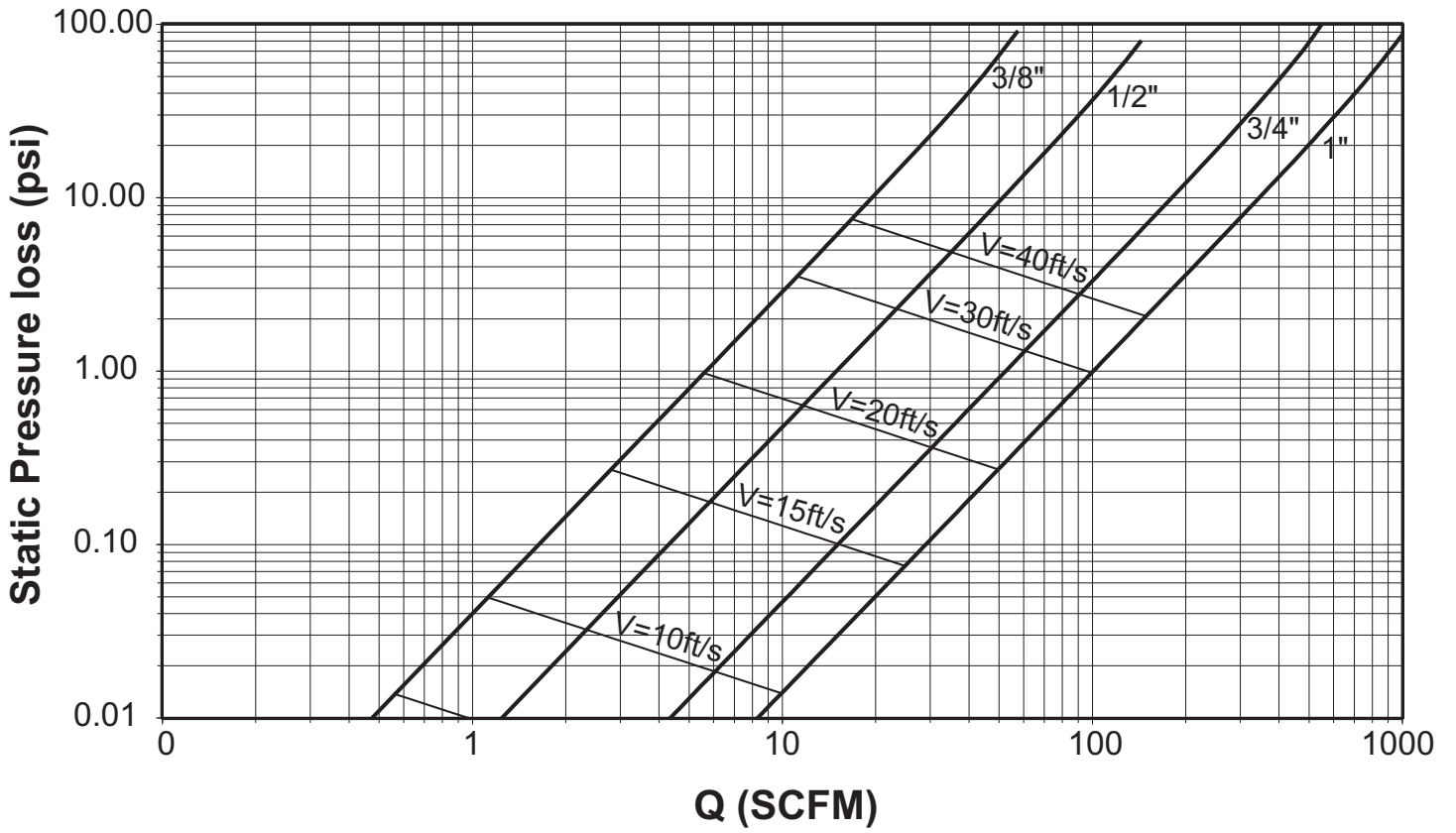

Figure C5
Pressure Loss per 100 Feet of Duratec Pipe
Air at 200psig (214.7psia), 60°F



NOTES

NOTES

SALES AND CUSTOMER SERVICE

U.S. Customers call IPEX USA LLC

Toll free: (800) 463-9572

www.ipexamerica.com

About the IPEX Group of Companies

As leading suppliers of thermoplastic piping systems, the IPEX Group of Companies provides our customers with some of the largest and most comprehensive product lines. All IPEX products are backed by more than 50 years of experience. With state-of-the-art manufacturing facilities and distribution centers across North America, we have established a reputation for product innovation, quality, end-user focus and performance.

Markets served by IPEX group products are:

- Electrical systems
- Telecommunications and utility piping systems
- Industrial process piping systems
- Municipal pressure and gravity piping systems
- Plumbing and mechanical piping systems
- PE Electrofusion systems for gas and water
- Industrial, plumbing and electrical cements
- Irrigation systems
- PVC, CPVC, PP, PVCO, ABS, PEX, FR-PVDF, NFRPP, FRPP, HDPE, PVDF and PE pipe and fittings (1/2" – 48")

Products manufactured by IPEX Inc. and distributed in the United States by IPEX USA LLC.

Elastolives™, Encase™, Enfield®, Floway™, Labline®, Neutrasystem2™, Neutratan® and Plenumline™ are trademarks of IPEX Branding Inc.

This literature is published in good faith and is believed to be reliable. However it does not represent and/or warrant in any manner the information and suggestions contained in this brochure. Data presented is the result of laboratory tests and field experience.

A policy of ongoing product improvement is maintained. This may result in modifications of features and/or specifications without notice.



IPEX